

Installation & Maintenance Instructions

PORTAFLOW 222 AND 333

Portaflow 222: Portable Ultrasonic Flow Meter

Portaflow 333: Portable Ultrasonic Heat Meter



Supplied by

247able.com

Call us on +44 (0)118 916 9420 | Email info@247able.com

Portaflow 222 and 333

Portaflow 222: Portable Ultrasonic Flow Meter

Portaflow 333: Portable Ultrasonic Heat Meter

User Manual



Portaflow 333HM shown

Micronics Ltd, Knaves Beech Business Centre,
Davies Way, Loudwater, High Wycombe, Bucks HP10 9QR

Telephone: +44(0)1628 810456

E-mail: sales@micronicsltd.co.uk

www.micronicsflowmeters.com

CONTENTS

1	INTRODUCTION	1
1.1	General Description	1
1.2	How Does It Work?	2
1.2.1	Reflex (V) Mode	4
1.2.2	Double Reflex (W) Mode	4
1.2.3	Triple Reflex (WV) Mode	4
1.2.4	Quadruple Reflex (WW) Mode	4
1.2.5	Diagonal Mode	4
1.3	Package Contents	5
1.4	Optional Equipment	7
1.5	Display and Connectors	8
1.6	Keypad	10
1.6.1	ON/OFF Key	10
1.6.2	Dual Function Numerical Keypad	10
1.6.3	Menus and the Menu Selection Keys	11
2	INSTALLATION	13
2.1	Positioning the Transducers	13
2.2	Attaching the Transducers	14
2.2.1	Cleaning the Contact Area	14
2.2.2	Assembling the Guide Rails on the Separation Bar	14
2.2.3	Fixing the Guide Rail Assembly to the Pipe	14
2.2.4	Fitting the Transducers	15
2.2.5	Fixing Transducers in Diagonal Mode	16
2.3	Connecting Temperature Probes (PF333HM Models Only)	18
2.4	Connecting Outputs	20
2.5	Connecting the Power Supply	21
2.5.1	Charging the Battery	21
2.5.2	Optimising Battery Life	21
2.6	Switching on for the First Time	22
2.6.1	Checking System Health	22
2.6.2	Selecting a Language	22
2.6.3	Setting the Date & Time	23
2.6.4	Enabling/Disabling the Backlight	23
2.6.5	Enabling/Disabling Audible Keypress	24
3	USING THE QUICK START MENU	25
3.1	Entering the Site Data	25
3.2	Attaching and Connecting the Flow Sensors	27
3.3	Taking a Flow Reading	27
3.4	Flow / Energy / Velocity Monitoring	28
3.5	Total Flows	28
3.5.1	Calculating the Average Flow or Power	29
3.5.2	Resetting Totals	29

4	MANAGING NAMED SITES.....	30
4.1	View/Edit Site Data	30
4.2	Selecting an Existing Site	31
4.3	Adding a New Site	32
4.4	Changing a Site Name.....	32
4.5	Editing Site Data.....	33
4.6	Changing Calibration Parameters	34
4.6.1	Adjusting the Zero Cutoff	34
4.6.2	Adjusting the Zero-Flow Offset (ZFO)	34
4.6.3	Adjusting the Calibration Factor.....	35
4.6.4	Adjusting the Roughness Factor.....	37
4.6.5	Adjusting the Damping Factor.....	38
5	LOGGING FUNCTIONS	39
5.1	Manual Logging	39
5.2	Scheduling Logging	39
5.3	Stopping Logging.....	40
5.4	Copying Logged Data to a USB Memory Stick.....	40
5.5	Clearing Log Files.....	41
5.6	Logger Status	41
6	OUTPUTS	42
6.1	Current Loop Setup	42
6.1.1	Example	43
6.1.2	Converting the Measured Current to Flow Rate	44
6.2	Digital Outputs	45
6.2.1	Pulse Output.....	46
6.2.2	Alarm Output	49
6.2.3	Frequency Output.....	51
7	NIMH POWER SCREEN.....	52
7.1	Power Checklist.....	52
8	HEAT METER	53
8.1	Calibrate Temperature Sensors	53
9	PRIMARY FLOW.....	55
10	MAINTENANCE AND REPAIR.....	56
11	TROUBLESHOOTING.....	57
11.1	Overview	57
11.2	General Troubleshooting Procedure	58
11.3	Warning and Status Messages	59
11.3.1	Flow Rate Errors & Messages	59
11.3.2	Heat Meter Errors & Messages.....	60
11.3.3	Current Loop and Digital Output Errors & Messages	60

11.3.4	Data Logging Errors & Messages	61
11.3.5	Battery Errors & Messages	63
11.3.6	Set-up and Other Errors & Messages	63
11.4	Test Block.....	65
11.5	Reset.....	66
11.6	Diagnostics.....	67
11.6.1	Advanced Diagnostics	68
12	APPENDIX	69
12.1	Specification	69
12.2	Declaration of Conformity	72

1 INTRODUCTION

1.1 General Description

The Portaflow range of portable flow meters uses clamp-on transducers to enable the flow of a liquid within a closed pipe to be measured accurately without needing to insert any mechanical parts through the pipe wall or protrude into the flow system.

Using ultrasonic transit time techniques, the Portaflow is controlled by a micro-processor system which contains a wide range of data that enables it to be used with pipes with an outside diameter ranging from 13mm up to 2000mm (depending on model) and constructed of a wide range of materials. The instrument will also operate over a wide range of fluid temperatures.

All models have the following standard features:

- Large, easy to read graphic display with backlighting.
- Simple to follow dual function keypad.
- Easy to follow 'Quick Start' set up procedure.
- Continuous signal monitoring.
- Three isolated switched outputs for use in any combination as a:
 - Pulse output (on volume or ¹energy),
 - Frequency output (on flow or ¹power), or
 - Alarm output (on flow, volume, ¹power, ¹energy, flow signal).
- Current output with a selectable range between 0 and 24mA including support for an alarm current.
- Rechargeable battery.
- Battery management.
- Diagnostics.

Volumetric flow rates are displayed in l/s, l/min, l/h, m³/s, m³/min, m³/h, Ml/s, Ml/min, Ml/hr, Ml/day, USgals/sec, USgals/min, USgals/h, USgals/day, Barrel/h, Barrel/day, ft³/sec, ft³/min, ft³/hr, MUSgal/hr), MUSgal/day, Imp Gals/sec, Imp. Gal/m, Imp Gals/hr, Imp Gals/day, Barrels/hr, Barrels/day. Linear velocity is displayed in metres or feet per second. When operating in the 'Flow Reading' mode, the total volumes, both positive and negative, are displayed up to a maximum 12-digit number.

The flowmeter can be used to measure clean liquids that have less than 3% by volume of particulate content. Cloudy liquids such as river water and effluent can be measured along with cleaner liquids such as demineralised water.

¹ On models with a heat-meter

Typical applications:

- River water
- Seawater
- Potable water
- Demineralised water
- Treated water

1.2 How Does It Work?

Portaflow flow meters use a cross correlation transit time algorithm to provide accurate flow measurements.

An ultrasonic beam of a given frequency is generated by applying a repetitive voltage pulse to the transducer crystals. This transmission goes first from the downstream transducer to the upstream transducer as shown in the upper half of Figure 1. The transmission is then made in the reverse direction, being sent from the upstream transducer to the downstream transducer as shown in the lower half of Figure 1. The speed at which the ultrasound is transmitted through the liquid is accelerated or decelerated slightly by the velocity of the liquid through the pipe. The subsequent time difference $T1 - T2$ is directly proportional to the liquid flow velocity.

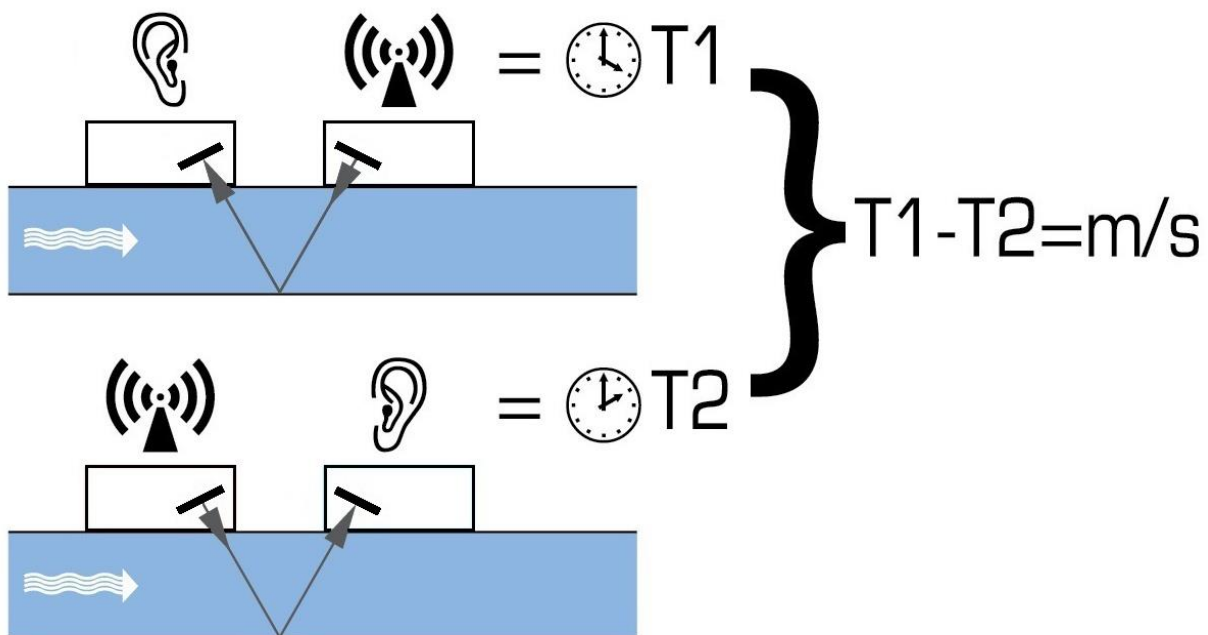

Figure 1 Principle of operation

The Portaflow system can be set up to operate in one of five modes determined mainly by the pipe diameter and the type of transducer set in use. Figure 2 illustrates the importance of applying the correct separation distance between the transducers to obtain the strongest signal.

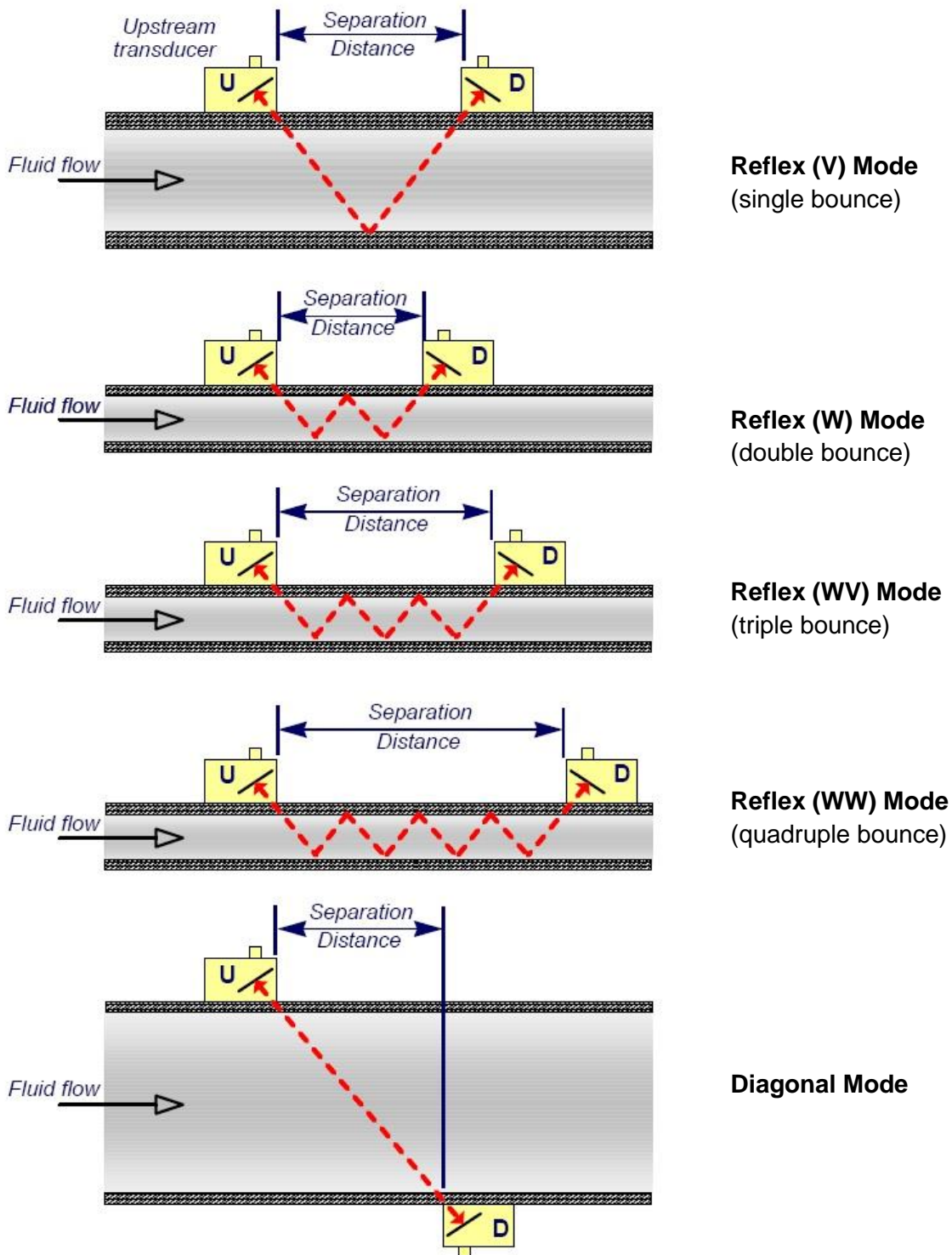

Figure 2 Operating modes

1.2.1 Reflex (V) Mode

This is the mode most commonly used. The two transducers (U & D) are attached to the pipe in line with each other and the signals passing between them are reflected by the opposite pipe wall.

The separation distance is calculated by the instrument in response to entered data concerning the pipe and fluid characteristics.

1.2.2 Double Reflex (W) Mode

In this mode the separation distance is calculated to give a double bounce². This is most likely to occur if the pipe diameter is small and the calculated reflex mode separation distance would be impractical for the transducers in use.

1.2.3 Triple Reflex (WV) Mode

This mode goes one step further to detect a triple bounce². This would normally be used when working with very small pipes relative to the transducer in use.

1.2.4 Quadruple Reflex (WW) Mode

This mode goes one step further again, to use a quadruple bounce². Again, this would normally be used when working with very small pipes relative to the transducer in use.

1.2.5 Diagonal Mode

This mode might be selected by the instrument where relatively large pipes are concerned. In this mode the transducers are located on opposite sides of the pipe, but the separation distance is still critical in order for the signals to be received correctly.

² In general, it should be noted that errors accumulate as the number of bounces increase. Units are calibrated using single reflex mode. Any inherent inaccuracy will be amplified by using higher order modes such as triple and quadruple bounce. In addition to this, as the path length is longer, the signal will also be more attenuated with higher order operating modes. Attenuation is also greater with sensors using higher operating frequencies. (E.g. Signals from A sensors will be more attenuated than with B sensors.)

1.3 Package Contents

The unit consists of the following components:

1. **Portaflow unit**
Incorporating keypad and backlit display (PF333 model shown, PF222 unit has light-grey case).
2. Power supply with UK/US/European adapters, 110/240VAC
3. Output signal cable (current loop & 3 digital outputs)
4. Transducer cables x 2, (2m)
5. Chains x 2 (3.3m)
6. Guide rails x 2
For use with A or B type transducers
7. Ultrasonic couplant
8. Tape measure
9. Transducer set 'A' for use on pipes 13mm to 115mm outside diameter. Transducer set 'B' for use on pipes 50mm to 2000mm outside diameter. (The Transducers received will depend on the configuration of the unit)
10. Test block
11. Syringe
12. Ruled separation bar (two piece)

Supplied with PF333HM models only:

13. Heatsink compound
14. RTD PT100 temperature sensor cable x 2
15. Steel banding x 2 (1.5m)

The kit also contains a copy of this manual.



All models

| PF333HM units only

Figure 3 Package Contents (PF333HM model shown)

1.4 Optional Equipment

A magnetic guide rail kit is available, as an optional extra, for use on mild steel and cast iron pipes (see Figure 4).



Figure 4 **Magnetic guide rail**

1.5 Display and Connectors

The Portaflow unit is microprocessor-controlled, operated through a menu system using an inbuilt LCD display and keypad. It can display the instantaneous fluid flow rate or velocity, together with totalised values.

The instrument can also provide a variable current or variable 'pulse' (volumetric, energy (PF333 HM only), or flow frequency) output that is proportional to the detected flow rate. In addition to this, the instrument can also be used to signal alarm conditions such as flow too high, too low or a volume being exceeded. This output can be calibrated to suit a particular flow range and used with a range of external interface devices, such as those found in Building management systems or site monitoring systems. The three isolated outputs provided can be configured as required in any order and with any functionality as just mentioned.

Portaflow 333HM units can be used to measure energy and power. They are supplied with clamp on RTD probes which, when properly placed, can be used to calculate energy lost or absorbed in a heater or chiller circuit. It does this by measuring the difference in temperature between the probes, which are usually placed on the flow and return pipes at the point of source. The unit is calibrated for ordinary water but is also capable of making an estimate when the system contains a proportion of glycol³.

Obviously, since this method of energy calculation relies on measuring the temperature on the outside of the pipe, the assumption made is that the temperature drop between the fluid and the outside wall is the same at both measurement points. With careful selection of measurement points on pipes whose wall and lining are good thermal conductors, a reasonable degree of accuracy in the measurement of the temperature differential is possible, however with pipe materials that are poor thermal conductors (e.g. plastic, epoxy etc.) it is recommended that PT100 pocket sensors be used instead. With the careful choice of sensor type and installation method, it may be possible to install these sensors without having to interrupt flow.

³ The proportions of water glycol are selected when choosing Fluid Type. The assumption is that the type of glycol is ethylene (C₂H₆O₂) with a Specific Heat Capacity (SHC) of 3.77kJ/kg°K, and a Relative Density (RD) of 1.05 @25°C.

It has also been found that the SHC of ethylene glycol-based additives varies significantly by brand. For this reason, and because the exact proportion and type of glycol being used are often not known, the energy values obtained when using a glycol/water mix should be considered at best, only an estimate. The SHC and RD for other fluid types should also be considered approximate. Published data for these other fluids often varies significantly and is dependent on many factors that are outside the scope of this instrument to compensate for.

Portaflow 333 units can also act as a data logger. When operating in the data logger mode, data is saved to non-volatile internal storage. This data may be downloaded at a later date via a flash drive inserted in the USB socket. Data is saved as text in a CSV file which may then be loaded directly into a program such as Microsoft™ Excel™. The internal storage capacity is 8GB.

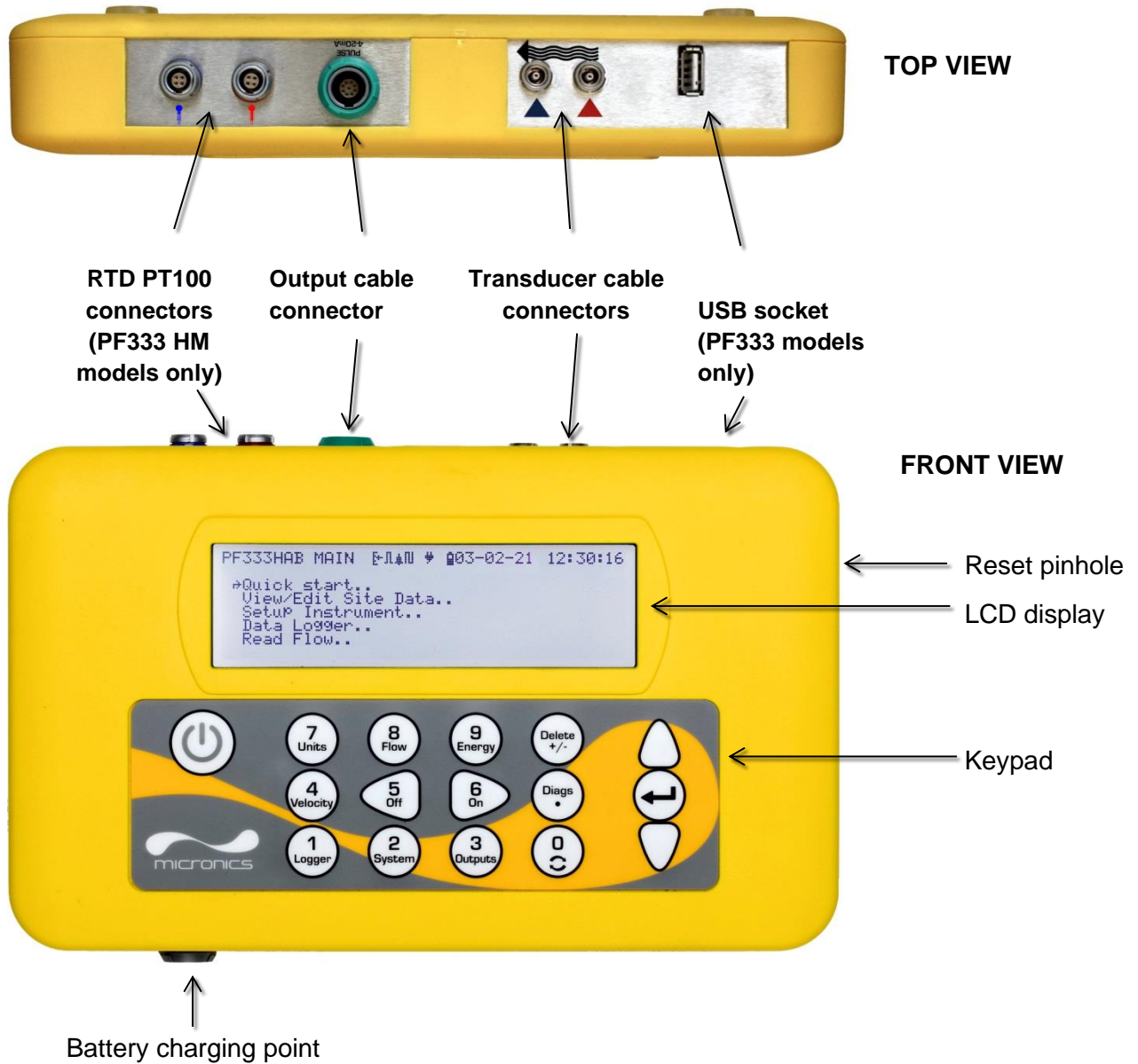

Figure 5 Portaflow unit (PF333HM model shown)

1.6 Keypad

The instrument is configured and controlled via a 16-key tactile membrane keypad, as shown in Figure 5.

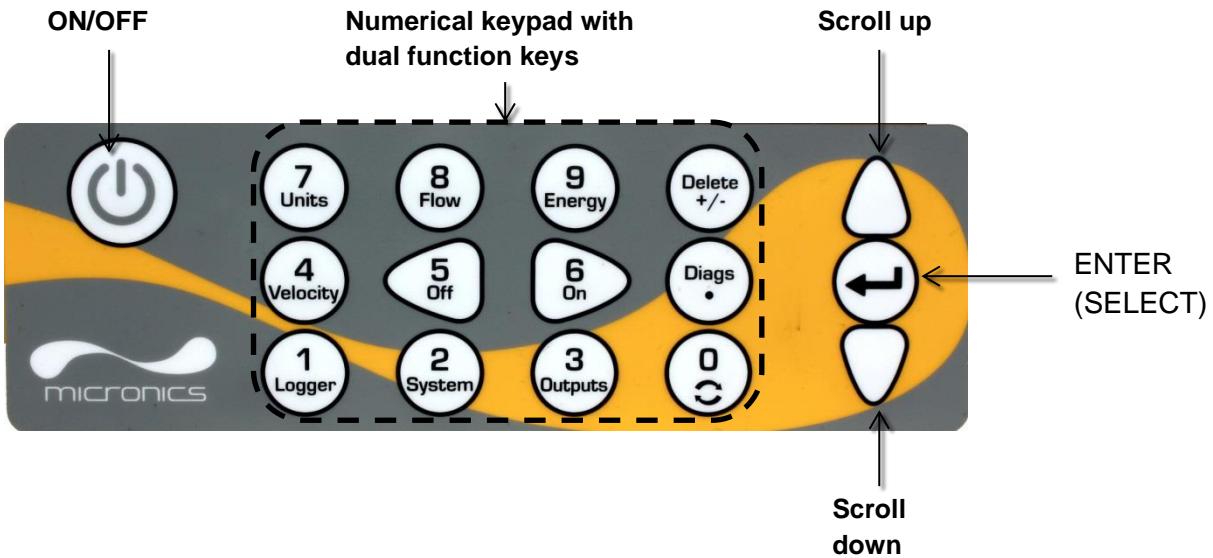

Figure 6 Portaflow keypad

1.6.1 ON/OFF Key

The ON/OFF key is on the top left of the keypad. When turned ON an initialisation screen is displayed on the LCD showing the instrument’s serial number and software revision. Once this appears, the instrument can be started by pressing the ENTER key once – the initialisation screen is then replaced by the MAIN MENU which provides access to the remaining functions.

1.6.2 Dual Function Numerical Keypad

The block of keys shown in the centre of the keypad in Figure 5 are dual function keys. They can be used to enter straight-forward numerical data within menus or provide quick access to frequently used menus or commands from the Read Flow/Velocity/Energy display screens. There is a distinction between short key presses (< 1.5 seconds) and long key presses (≥ 1.5 seconds). All key press operations in this document are short key presses unless otherwise stated.

NOTE: SOME OF THE FEATURES ACCESSED BY THESE KEYS ARE UNAVAILABLE IN THE PORTAFLOW MODEL 222 RANGE.

Key	Use
0	Circulate between flow, velocity and optionally energy screens (via a short press when reading flow, energy or velocity), enter the zero-flow setting screen (long press when reading flow), or freeze and un-freeze diagnostic values in the Diagnostic screen
1	PF333 models only: Display the Logger menu (see page 39)
2	Display the System Settings menu (see page 22)
3	Display the Output Board Setup menu (see page 42)

Key	Use
4	Switch to the Read Velocity display from the Read Flow display or Read Energy display (PF333 models only)
5	No function - reserved for future use
6	No function - reserved for future use
7	Cycle through the available display units
8	Switch to the Read Flow display from the Read Velocity display or Read Energy display (PF333 models only)
9	PF333 models only: switch to the Read Energy display from the Read Velocity display or Read Flow display
Delete +/-	No shortcut function: within text entries, deletes character to left of flashing cursor. Deletes alarms when activated, or return to the MAIN MENU from the Summary screen
Diags .	Display the Diagnostics screen (see page 67)

1.6.3 Menus and the Menu Selection Keys

To navigate the Portaflow's menu system, use the three keys on the right-hand side of the keypad:

1. Use the UP & DOWN arrow keys to scroll through a menu list and select a menu item, as indicated by an arrow-shaped cursor on the left-hand side of the screen.
2. Edit or open the active menu choice by pressing the ENTER key.
3. Use the UP and DOWN arrow keys to cycle through the available options or, for numerical settings, use the keypad to enter the required value.
4. Press the ENTER key to confirm the new setting.

Some menus have more options than can be shown on the screen at the same time, in which case the 'overflowed' choices can be brought into view by continuing to scroll beyond the lowest visible item.

Menus generally 'loop around' if you scroll beyond the first or last items. Sometimes, this is the quickest route to find the **Exit** command to close a menu.

If you select **Exit** on any menu it usually takes you back up one level in the menu hierarchy, but in some cases, it may go directly to the *Read Flow* screen.

Menu items ending with ".." generally indicate that selection of this item will take you to another screen.



Figure 7 **Main menu**
(*Read Energy* and *Data Logger* options available with PF333HM models only)

2 INSTALLATION

2.1 Positioning the Transducers

For accurate measurements, the transducers must be installed at a position where the fluid flows uniformly. Flow profile distortions can result from upstream disturbance such as bends, tees, valves, pumps and other similar obstructions. To ensure a uniform flow profile, the unit must be mounted away from any cause of flow disturbance.

As a guide, we suggest this is best achieved by ensuring there is a straight length of pipe upstream of the transducers of at least 10 times the pipe diameter, and 5 times the pipe diameter on the downstream side, as shown in Figure 8, but this may vary. Flow measurements can be made on shorter lengths of straight pipe, but when the transducers are mounted this close to any obstruction the resulting inaccuracies can be unpredictable.

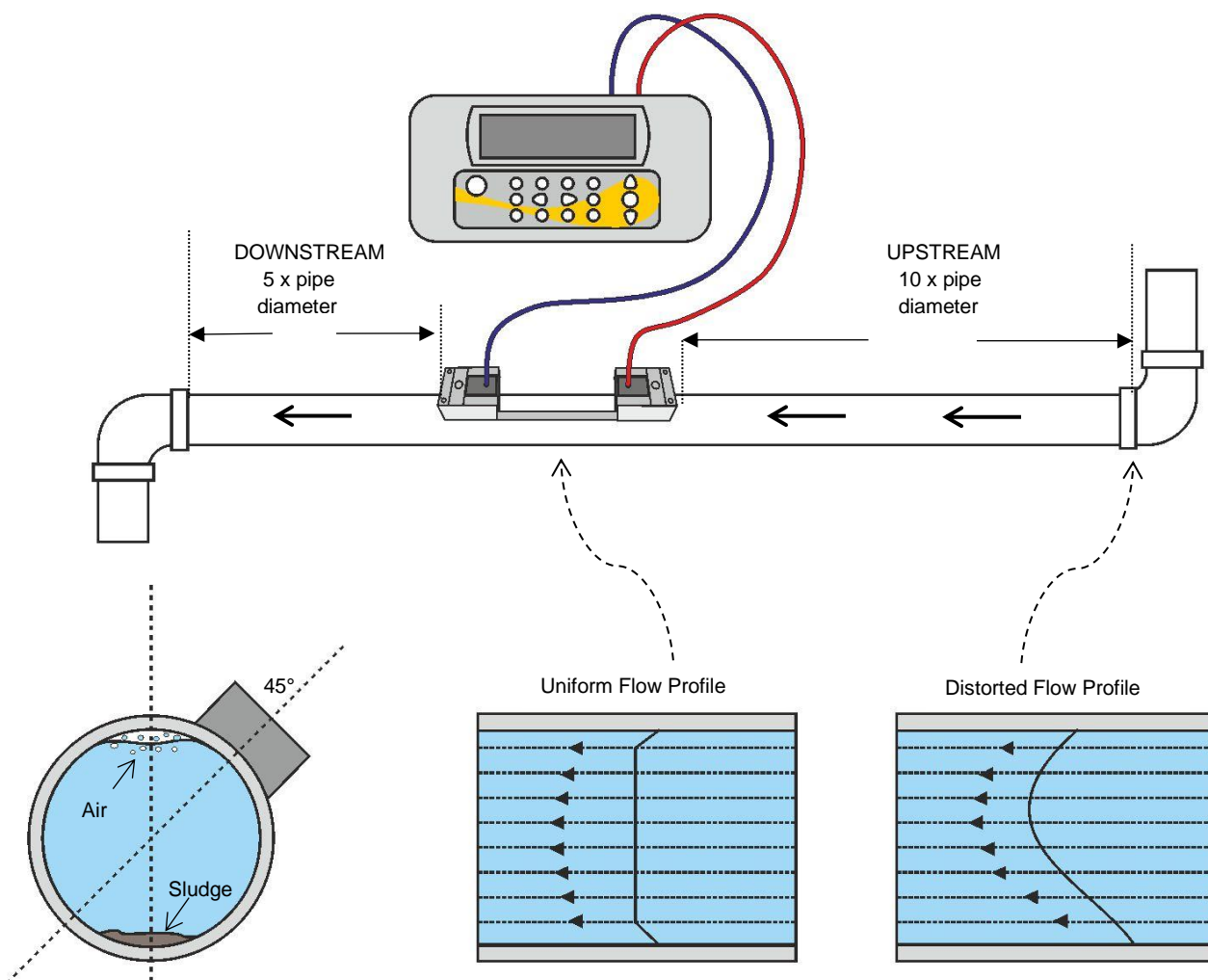

Figure 8 Location of unit

To obtain the most accurate results, the condition of both the liquid and the pipe must be suitable to allow ultrasound transmission along the predetermined path.

In many applications, an even flow velocity profile over a full 360° is unattainable due, for example, to the presence of air turbulence at the top of the flow and also possibly sludge at the bottom of the pipe. Experience has shown that the most consistently accurate results are achieved when the sensors are mounted at 45° with respect to the top of the pipe.

IMPORTANT: DO NOT EXPECT TO OBTAIN ACCURATE RESULTS IF THE UNIT IS POSITIONED CLOSE TO ANY OBSTRUCTION THAT DISTORTS THE UNIFORMITY OF THE FLOW PROFILE. MICRONICS LTD ACCEPTS NO RESPONSIBILITY OR LIABILITY IF PRODUCT HAS NOT BEEN INSTALLED IN ACCORDANCE WITH THESE INSTRUCTIONS.

2.2 Attaching the Transducers

Type 'A' & 'B' transducers connect to adjustable guide rails secured to the pipe using wrap-around chains.

For Reflex Modes, the guide rails are mechanically connected together by an aluminium separation bar. The separation bar ensures correct alignment and also acts as a ruler to allow the distance between the transducers to be accurately set to the value indicated by the Portaflow unit.

For Diagonal Mode, the transducer guide rails must be fitted on opposite sides of the pipe. It is necessary to accurately mark out the required positions to ensure that the transducers are correctly aligned, directly opposite each other, and at the required separation (see Section 2.2.5).

NOTE: THE USE OF CHAINS TO FIX THE GUIDE RAILS TO THE PIPE CAN BE ELIMINATED ON MILD STEEL OR IRON PIPES BY USING THE OPTIONAL MAGNETIC GUIDE RAILS. IN ALL OTHER RESPECTS THE SETTING UP OF THE SENSORS IS THE SAME AS FOR STANDARD GUIDE RAILS.

2.2.1 Cleaning the Contact Area

Prepare the pipe by degreasing it and removing any loose material or flaking paint in order to obtain the best possible surface. A smooth contact between pipe surface and the face of the sensors is an important factor in achieving a good ultrasound signal strength and therefore maximum accuracy.

2.2.2 Assembling the Guide Rails on the Separation Bar

1. Slide the separation bar into the front of the left-hand guide rail, align the front edge of the guide rail with '0' on the ruler scale and secure it in place by tightening the thumbscrew.
2. Slide the other end of the separation bar into the front of the right hand guide rail, align the front edge of the guide rail to the required separation distance (obtained from the Portaflow unit – see page 25) on the ruler, then secure it in place by tightening the thumbscrew.

NOTE: IF MAGNETIC GUIDE RAILS ARE USED ON MILD STEEL OR IRON PIPES THEN ONLY THE LOCATION AT 45° ON THE PIPE APPLY ON THE NEXT TWO SECTIONS.

2.2.3 Fixing the Guide Rail Assembly to the Pipe

1. On each guide rail, attach one end of a securing chain to a hook on the tensioning bar, wrap the chain around the pipe and then attach it to the hook on the other end of the tensioning bar whilst keeping the chain as tight as possible.

2. Rotate the complete guide rail assembly so that it is approximately 45° with respect to the top of the pipe. Then tighten the chain by turning the tensioning thumb-wheel on each guide block until the assembly is securely attached to the pipe.

NOTE: IF YOU ARE UNABLE TO GET SUFFICIENT TENSION ON THE CHAIN TO HOLD THE ASSEMBLY IN PLACE, FULLY SLACKEN THE TENSIONING THUMB-WHEEL AND SHORTEN THE EFFECTIVE LENGTH OF THE CHAIN WRAPPED AROUND THE PIPE BY CONNECTING THE TENSIONING BAR TO THE NEXT LINK IN THE CHAIN, THEN RE-TENSION.

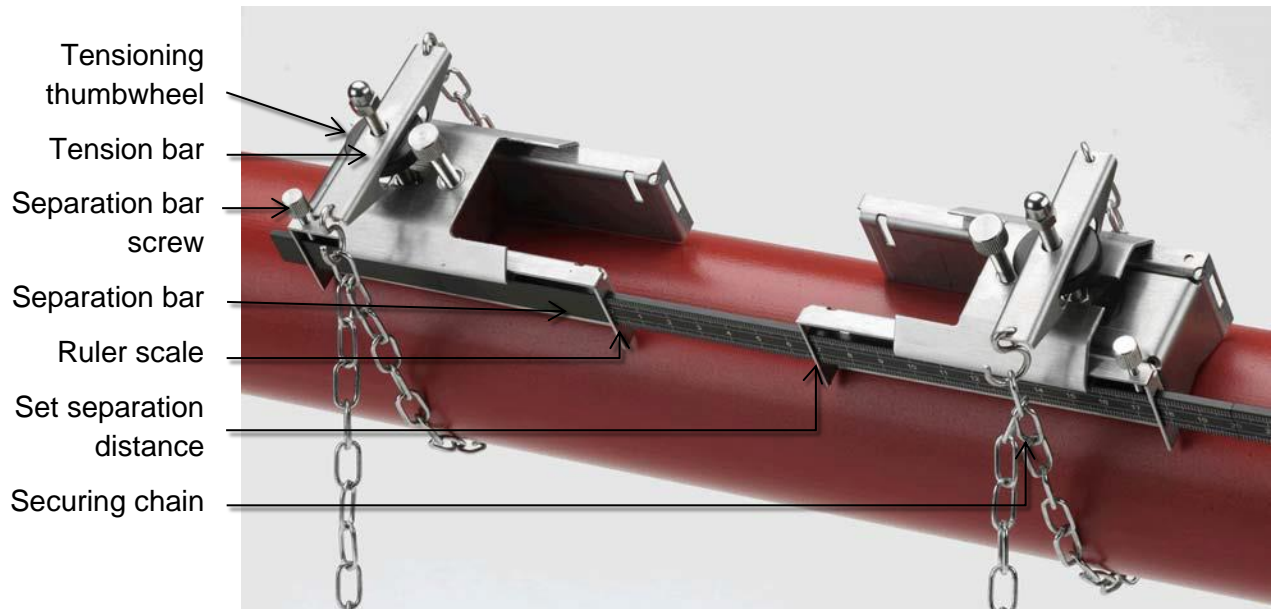

Figure 9 Guide rail assembly (Reflex Mode)

2.2.4 Fitting the Transducers

1. Slide the transducer cover plate fully towards the outside of the guide assembly to allow sufficient access to fit the transducer.
2. Clean the face of the transducer, removing all traces of dirt and grease.
3. Apply a 3mm bead of ultrasonic couplant along the centre length of the transducer.



Figure 10 Applying ultrasonic couplant

4. Fit the transducer into the guide block – ensuring the lugs on the sides of the transducer are correctly located into the slots on the sides of the guide block.

5. Slide the transducer cover plate over the top of the transducer and tighten the thumbscrew finger-tight to secure the transducer in place. When securing the cover plate take care to leave sufficient room around the transducer connector to connect the cable.
6. Repeat the above steps for the second transducer.
7. Connect the transducers to the Portaflow unit using the coaxial cables provided. The RED cable must be connected to the upstream transducer and the BLUE cable to the downstream transducer. The sockets are also colour-coded.

NOTE. IF YOU OBSERVE NEGATIVE FLOW, SWAP THE RED AND BLUE CABLES AT THE SENSOR END. PLEASE NOTE SECTION 4.6.2 ON ZERO FLOW OFFSET.

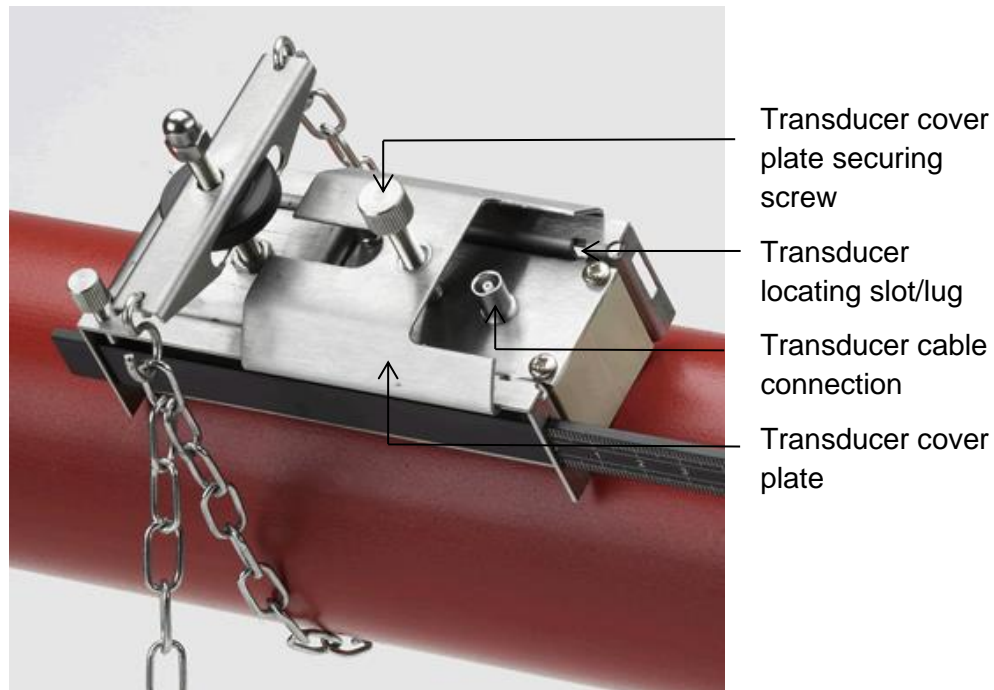

Figure 11 Transducer in guide rail

2.2.5 Fixing Transducers in Diagonal Mode

For Diagonal Mode, the transducer guide rails must be fitted on opposite sides of the pipe. It is necessary to accurately mark out the required positions to ensure that the transducers are correctly positioned and aligned along the axis of the pipe, directly opposite each other on a 45° axis with respect to the top of the pipe, and at the required separation.

To position the transducers:

1. Obtain and note the separation distance between the transducers using the Quick Start menu (see page 25).
2. Mark a reference line around the pipe approximately where the upstream transducer is to be fitted. A method for marking a perpendicular circumference is described on the next page.
3. Mark a position approximately 45° from the top of the pipe. This is the location for the upstream transducer.
4. From this point, draw a line equal to the separation distance and parallel to the pipe axis in the downstream direction.

5. At this point, draw another line around the circumference of the pipe.
6. Mark the position 180° from the upstream transducer's position. This is the location for the downstream transducer.

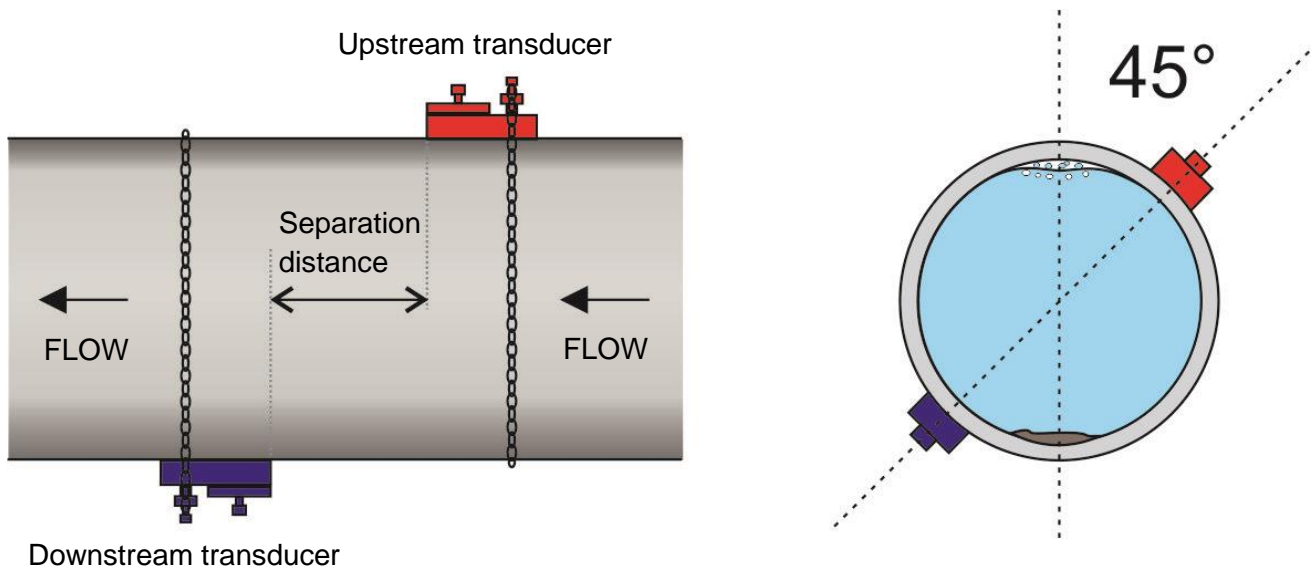

Figure 12 Transducer locations for Diagonal Mode

HINT: AN EASY WAY TO DRAW A PERPENDICULAR CIRCUMFERENCE AROUND A LARGE PIPE IS TO WRAP A LENGTH OF MATERIAL SUCH AS CHART PAPER AROUND THE PIPE, ALIGNING THE EDGES OF THE PAPER PRECISELY AT THE OVERLAP. WITH THE EDGE OF THE CHART PAPER BEING PARALLEL, EITHER EDGE DESCRIBES A CIRCUMFERENCE AROUND THE PIPE THAT IS PERPENDICULAR TO THE PIPE AXIS.

MARK THE CHART PAPER EXACTLY WHERE IT OVERLAPS. THEN, AFTER REMOVING THE PAPER FROM THE PIPE, FOLD THE MEASURED LENGTH IN HALF KEEPING THE EDGES PARALLEL. THE FOLD LINE NOW MARKS A DISTANCE EXACTLY HALF WAY AROUND THE PIPE.

PUT THE PAPER BACK ON THE PIPE AND USE THE FOLD LINE TO MARK THE OPPOSITE SIDE OF THE PIPE.

Having marked the positions for the transducers, follow the instructions in the preceding sections to:

- Clean the contact areas (see Section 2.2.1)
- Fix the guide rails on the pipe (see Section 2.2.3)
- Fit the transducers (see Section 2.2.4)

2.3 Connecting Temperature Probes (PF333HM Models Only)

The temperature sensors must be located at the flow and return of the system that is being monitored. The area of pipe where they are to be attached must be free of grease and any insulating material. It is recommended that any coating on the pipe is removed so that the sensor has the best possible thermal contact with the pipe⁴.

For optimum reliability on boiler applications, the flow measurement needs to be made on the cold side of the system. For optimum reliability in chiller applications, the flow measurement needs to be made on the warmer side of the system.

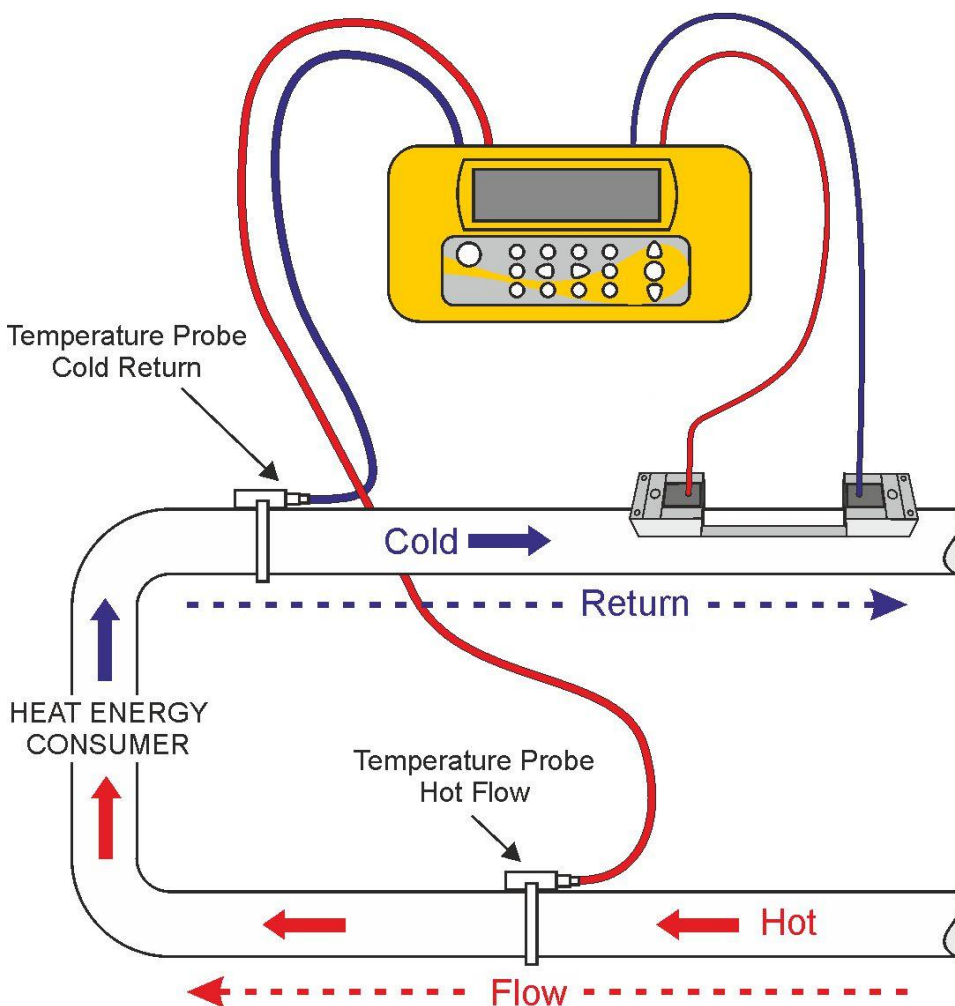

Figure 13 Portaflow 333 Temperature Probe Positioning (Heater system)

⁴ It must be kept in mind that this is the reading on the outside of the pipe, which may vary significantly from the actual fluid temperature, especially if the pipe material is of some type of insulating material. This does not necessarily invalidate energy readings since the readings are dependent on the temperature differential, not the absolute temperature. It is the responsibility of the installer to ensure the differential temperature readings are as accurate as possible. This may necessitate covering the sensors with insulating material to ensure drafts and differences in ambient temperature are minimised for both sensors.

The sockets on the Electronics Module are marked Red (Hot) and Blue (Cold) – see Figure 5 and Figure 14.

This defines the location of the temperature sensors on installations where heat is being extracted from the system.

Note that in Figure 13, a heating system is depicted, but the same notion of temperature applies to a chiller system. In this case the ‘cold’ sensor will be placed on the flow pipe and the ‘hot’ sensor should be placed on the return pipe.

Two separate 4-core plug-in cables are provided for the Temperature Sensor Probes connections.

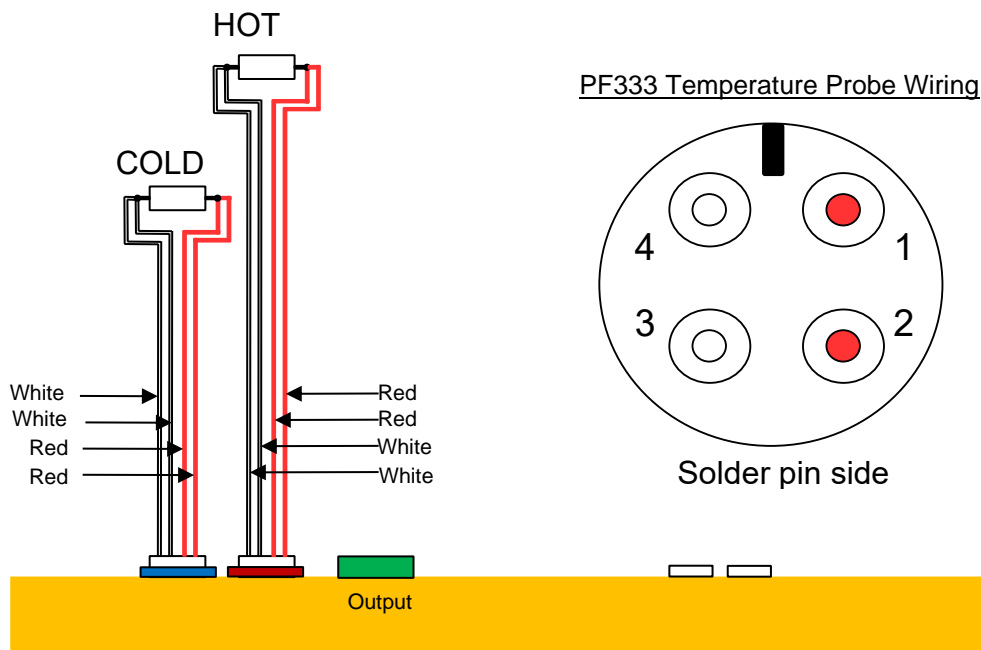

Figure 14 PF333 Temperature Probe Wiring

2.4 Connecting Outputs

The output cable provides a current source that can drive a maximum load of $< 600\Omega$ and 3 digital output pairs for pulse, frequency or alarm outputs.

The isolated pulse output is provided by a SPNO/SPNC MOSFET relay which has a maximum load current of 500mA and maximum load voltage of 24V AC/DC.



THIS OUTPUT IS SUITABLE FOR SELV CIRCUITS ONLY.

The pulse output is a Volt or potential free contact and when selected as an alarm, is configurable as NO/NC.

The current output is available on the white (high polarity) and black (low polarity) wire pairs (pins 1&2 on the connector). The alarm current due to an out-of-bounds condition must be set outside the working range.

Using the instrument's menu system (see page 42), you can:

- Select the current output function **Off/On**
- Select the current output range (set the current range, where 4-20mA, 0-20mA, 0-16mA are common ranges), but the device is capable of generating currents of up to 24mA
- Calibrate the current output signal to a required flow range
- Select the alarm cause (and alarm current for the current output)
- Set a trigger value for the alarm when it is associated with *Under Value* or *Exceeds Value*
- Set current trim values to accommodate any inaccuracies in the user's system

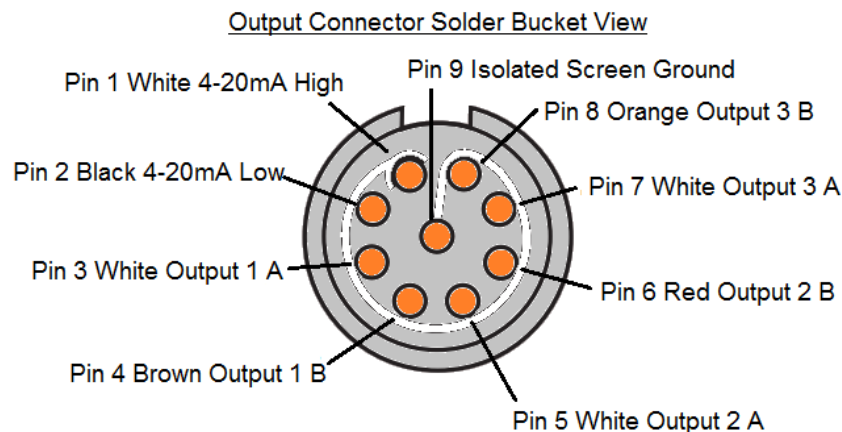

Figure 15 Output Wiring

The three digital output pairs for pulse or alarm outputs are as follows:

Output	Pin outs	Wire pair
Output 1	Pins 3 & 4	Brown/White
Output 2	Pins 5 & 6	Red/White
Output 3	Pins 7 & 8	Orange/White

2.5 Connecting the Power Supply

Operating power is provided by an internal battery that can be charged from the utility supply using the supplied external charger. When you first receive the unit, you should charge the battery for a minimum of 15 minutes before use. It is possible to use the unit while the battery is charging but if the charging fails the unit may automatically switch off. A fully charged battery will power the instrument for up to 13hrs depending on the output utilisation and backlight usage.

2.5.1 Charging the Battery

1. Connect the external battery charger to the charger socket at the bottom of the instrument then switch on the utility supply.
2. When switched on, the instrument indicates charging with an animated battery symbol to the left of the date. It will also indicate that the device is being powered externally by a plug symbol in the top status line.
3. Leave the instrument on charge for at least 15 minutes before using it for the first time.

2.5.2 Optimising Battery Life

The backlight can be configured in the Setup Instrument menu (see page 23) to be either permanently OFF, timed to switch off after 5-120s of keypad inactivity, or permanently ON. If the backlight is active continuously it will reduce the available battery operating time to around 10 hrs (depending on output conditions). Similarly, if the current loop output is used constantly at high currents, the battery life may be reduced even further. It is therefore beneficial to turn off the backlight and current loop output facilities when they are not required.

A warning message is triggered if the internal battery voltage falls below a set threshold, at which point there are tens of minutes of battery operation remaining (depending on usage). If the battery is left to discharge further, the unit is designed to shut down before the battery is completely exhausted. In this situation, all operations, including logging, will be stopped.

The battery can be charged either while the instrument is in use or when switched off.

The instrument's internal data is stored in non-volatile memory and will not be lost even if the battery discharges completely.



THE BATTERY IS NOT A USER-CHANGEABLE ITEM. THE INSTRUMENT MUST BE RETURNED TO YOUR DISTRIBUTOR IF THE BATTERY NEEDS REPLACING.



ONLY USE THE SUPPLIED CHARGER, OR SPECIAL ADAPTOR LEAD. FAILURE TO COMPLY WITH THIS WILL INVALIDATE YOUR WARRANTY.

2.6 Switching on for the First Time

Leave the instrument on charge for at least 15 minutes before using it for the first time.

Switch on the instrument by pressing and holding down the ON/OFF button for about 2 to 3 seconds. Wait for the banner screen to be fully displayed. The battery symbol in the top right of the screen roughly indicates the level of the battery charge.

Press the ENTER key to display the *Main* menu.

2.6.1 Checking System Health

This operation should be checked after powering up the unit for the first time, but it is useful to check periodically that all systems are operating properly, especially if errors were reported when entering the *Main* menu.

1. From the *Main* menu, use the Up and Down scroll keys to select **Setup Instrument**. Press the ENTER Key.
2. A list of options will be displayed depending on the Portaflow model. It should be noted that a status message will appear to the right of the option name. If the sub-system implementing the option is working correctly, the status will read "OK". If any subsystem has a fault, two dashes will be visible.
3. If a subsystem is NOT reading OK at start-up, try restarting the Portaflow by turning it off then on again. If the error persists, contact your distributor or return the item for repair.

2.6.2 Selecting a Language

English is the default display language. German, French and Spanish options are also available. To change the language:

1. From the *Main* menu, use the Up and Down scroll keys to select **Setup Instrument**. Press the ENTER Key. With **System** selected in the *Options* menu, press the ENTER Key.

Alternatively, from a *Read Flow/Velocity/Energy* screen, press the SYSTEM key (2). The *System Settings* menu is displayed.

2. Use the UP/DOWN arrow keys to select **Language**. Press the ENTER key.
3. Use the UP/DOWN arrow keys to scroll through the available options.
4. With the required language highlighted, press the ENTER key.
5. Use the UP/DOWN arrow keys to select **Save Setup & Exit**. Press the ENTER key.

The selected language is now active for all screens.

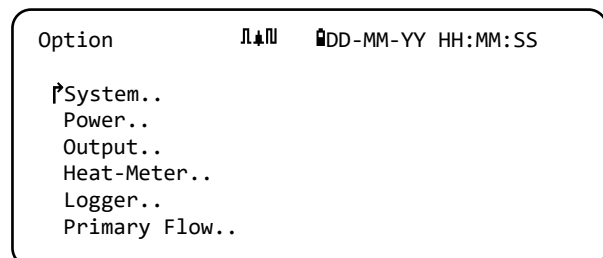
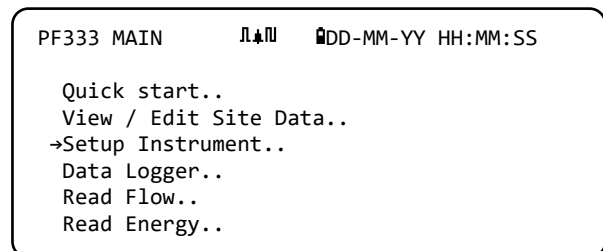

2.6.3 Setting the Date & Time

- From the MAIN menu, use the Up and Down scroll keys to select **Setup Instrument**. Press the ENTER Key. With **System** selected in the *Options* menu, press the ENTER Key.

Alternatively, from a *Read Flow/Velocity/Energy* screen, press the SYSTEM key (2). The *System Settings* menu is displayed.

System Settings		DD-MM-YY H:MM:SS
Lock-screen Timeout	90	sec
Back-light mode	ON	
Back-light Timeout	75	sec
Set Date & Time..		
Reset Totals..		
Damping	10	sec

- Use the UP/DOWN arrow keys to select **Set Date & Time**. Press the ENTER key. The *Set Date & Time* menu is displayed.
- The instrument is configured to display dates in *DD-MM-YY* format. Proceed to step 6 unless you prefer to use *MM-DD-YY* format.

Set Date & Time		DD-MM-YY HH:MM:SS
Set Date & Time	DD-MM-YY.HH:MM:SS	
Mode	DD-MM-YY	
Exit		

- Use the UP/DOWN arrow keys to select **Mode**. Press the ENTER key.
- Use the UP/DOWN arrow keys to choose the required format: *DD-MM-YY* or *MM-DD-YY*. Press the ENTER key. The date and time format will immediately be updated.
- Use the UP/DOWN arrow keys to select **Set Date & Time**. Press ENTER. A flashing cursor appears under the first date number. Enter the date and time sequence in *DD-MM-YY-HH-MM-SS* format then press the ENTER key.
- Scroll down and select **Exit** then press the ENTER key to return to the MAIN menu.

NOTE: IF YOU MAKE A MISTAKE WHEN ENTERING THE DATA PRESS THE DELETE KEY TO MOVE THE CURSOR BACK TO THE NUMBER YOU WISH TO CHANGE, THEN CONTINUE. IF YOU ENTER AN INVALID NUMBER AN 'ERR:INVALID DATE OR TIME!' OR 'BADLY FORMATTED DATE OR TIME' ERROR MESSAGE IS DISPLAYED ON THE SECOND LINE OF THE SCREEN. IF THIS OCCURS REPEAT THE SET DATE/TIME PROCEDURE.

2.6.4 Enabling/Disabling the Backlight

The backlight can be selected to be *OFF*, *TIMED* (illuminated until a set interval of keypad inactivity occurs), or *ON* permanently. If the backlight is not required it is recommended that you disable it or use the *TIMED* option to prolong the battery discharge time.

System Settings		DD-MM-YY HH:MM:SS
Back-light mode	On	
Back-light Timeout	75	sec
Audible keypress	Off	
Set Date & Time..		
Display Total	Both	
Reset Totals..		

- From the MAIN menu, use the Up and Down scroll keys to select **Setup Instrument**. Press the ENTER Key. With **System** selected in the *Options* menu, press the ENTER Key.

Alternatively, from a *Read Flow/Velocity/Energy* screen, press the SYSTEM key (2). The *System Settings* menu is displayed.

- Use the UP/DOWN arrow keys to select **Back-light mode**. Press the ENTER key.
- Use the UP/DOWN arrow keys to scroll through the available options: *On/Timed/Off*.

4. With the chosen mode selected, press the ENTER key.
5. If you select *TIMED*, use the UP/DOWN arrow keys to select to **Back-light Timeout**. Press the ENTER key.
6. Use the keypad to enter the required timeout interval (5-120s). Press the ENTER key.
7. Select **Save Setup & Exit** then press the ENTER key to return to the *Options* menu.
8. Select **Exit** then press the ENTER key to return to the *Main* menu.

2.6.5 Enabling/Disabling Audible Keypress

When enabled, the **Audible keypress** option provides feedback that a key has been released:

- When a key is pressed for a short period of time, a very short beep will be heard.
- When a key is pressed for a long time, a beep of up to half a second will be heard.

To change the **Audible keypress** option:

1. From the MAIN menu, use the Up and Down scroll keys to select **Setup Instrument**. Press the ENTER Key. With **System** selected in the *Options* menu, press the ENTER Key.

Alternatively, from a *Read Flow/Velocity/Energy* screen, press the SYSTEM key (2). The *System Settings* menu is displayed.

2. Use the UP/DOWN arrow keys to select **Audible keypress**. Press the ENTER key.
3. Use the UP/DOWN arrow keys to scroll through the available options: *On/Off*.
4. With the chosen mode selected, press the ENTER key.
5. Note that key beeps will be active immediately
6. Select **Save Setup & Exit** then press the ENTER key to return to the *Options* menu.
7. Select **Exit** then press the ENTER key to return to the *Main* menu.

System Settings		DD-MM-YY HH:MM:SS
↑ Audible keypress		ON
Set Date & Time..		
Display Total		Both
Reset Totals..		
Damping Mode		Fixed
Damping Time		10 sec

3 USING THE QUICK START MENU

If you want to perform a 'one-off' flow reading at a particular pipe location the *Quick start* wizard provides the simplest way to set up the Portaflow system and access the FLOW READING screen.

If the point at which you intend to take the measurement is likely to require regular monitoring it is best to set it up as a 'Site' within the Portaflow, which then stores the site parameters (See Chapter 4).

Before you can use the Portaflow system you need to obtain the following details (this information will be required when setting up the *Quick start* wizard):

- Pipe outside diameter or circumference.
- Pipe wall thickness and material.
- Pipe lining thickness and material.
- Type of fluid.
- Fluid temperature.

3.1 Entering the Site Data

1. Select *Quick start* from the MAIN MENU and press the ENTER key. You will then be presented with a series of screens in which to enter the data mentioned above.
2. Enter the pipe's outside diameter (15 – 2000 mm or its circumference (47.1 – 6283.2 mm). When you enter one value the other is calculated from it.

Select CONTINUE and press the ENTER key.

3. Enter the pipe wall thickness (0.5 – 50 mm).

Select CONTINUE and press the ENTER key.

4. Choose the pipe wall material: *Plastic/Cast Iron/Ductile Iron/Copper/Brass/Concrete/Glass/Other (m/s)/Mild Steel/S'less Steel 316/S'less Steel 303*. If the material is not listed, select *Other (m/s)* and enter the propagation rate of the pipe wall material in metres/sec. Contact Micronics if this is not known.

Select CONTINUE and press the ENTER key.

```
PF333 MAIN      ⏏ DD-MM-YY HH:MM:SS
Quick start..
View/Edit Site Data..
Setup Instrument..
Data Logger..
Read Flow..
Read Energy..
```

```
Pipe Outside Di ⏏ DD-MM-YY HH:MM:SS
Pipe outside diameter 114.30 mm
Pipe circumference 359.08 mm
Continue..
Main Menu..
```

```
Pipe Wall Thick ⏏ DD-MM-YY HH:MM:SS
Pipe wall thickness 8.00 mm
Continue..
Main Menu..
```

```
Pipe Wall Mater ⏏ DD-MM-YY HH:MM:SS
Pipe wall material Plastic
Continue..
Main Menu..
```

Identify the pipe lining material from the following options:
None/Rubber/Glass/Epoxy/Concrete/Other (m/s). If the material is not listed, select *Other (m/s)* and enter the propagation rate of the pipe wall material in metres/sec. Contact Micronics if this is not known.

5. Select CONTINUE and press the ENTER key.
6. If no lining material was entered, go to step 7. Otherwise, enter the lining thickness (0 – 40 mm).

Select CONTINUE and press the ENTER key.

7. Select the fluid type from the following options:
Water/Glycol/water 50%/Glycol/water 30%/Lubricating oil/Diesel/Freon/Other (m/s). If the fluid is not listed, select *Other (m/s)* and enter the propagation rate of the fluid in metres/sec. Contact Micronics if this is not known.

Note: If *Other* is selected, enter the speed of sound (SoS) in metres per second, of the wall material. After entry of the SoS, the user will be taken to the following screen as would have been the case if another selection was made.

Select CONTINUE and press the ENTER key.

8. Enter the fluid temperature (-30 – 135.0 °C) at the point the meter is installed.

Select CONTINUE and press the ENTER key.

9. **PF333 Models Only:** Specify how the Heat meter is configured: *Hot Sensor/Cold Sensor/Fluid Temperature*.

Program the unit with the temperature of the fluid at the point where the flow meter is installed to account for any variations in relative density and specific heat capacity. If the meter is installed at a point some way from either the hot of cold sensor, select the temperature entered in the previous step.

Select CONTINUE and press the ENTER key.

```

Pipe Lining      ⏏⏏⏏  DD-MM-YY HH:MM:SS
↳Lining material      Glass
Continue..
Main Menu..
    
```

```

Pipe Lining Thi ⏏⏏⏏  DD-MM-YY HH:MM:SS
↳Pipe Lining thickness  1.0      mm
Continue..
Main Menu..
    
```

```

Fluid Type      ⏏⏏⏏  DD-MM-YY HH:MM:SS
↳Select fluid type      Water
Continue..
Main Menu..
    
```

```

Fluid Temperatu ⏏⏏⏏  DD-MM-YY HH:MM:SS
↳Fluid Temperature      14.0°C
Continue..
Main Menu..
    
```

```

Heat-meter      ⏏⏏⏏  DD-MM-YY HH:MM:SS
↳Installation Side Hot Sensor
Sensor Type      PT100
Continue..
Main Menu..
    
```

- The *Summary* screen is displayed. This displays a summary of the entered parameters and informs you of the type of sensor to be used, the mode of operation and the distance to set up between the sensors.
In this example, A-ST (A standard) sensors are recommended, operating in the 'Reflex' mode, spaced at 69.9mm apart.

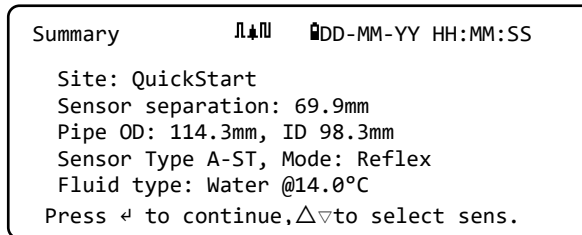

NOTE: DO NOT PRESS THE ENTER KEY UNTIL THE CORRECT TRANSDUCERS ARE FITTED AND CONNECTED TO THE INSTRUMENT. IF THE DATA CONTAINS A MISTAKE, PRESS THE DELETE KEY TO RETURN TO THE MAIN MENU AND RESTORE THE PREVIOUS SETTINGS.

- If you prefer to use a different configuration, press the UP or DOWN arrow key to select a different sensor set and mode.

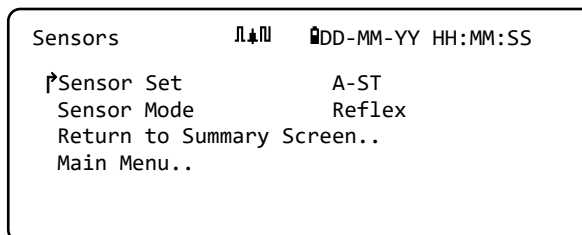

NOTE: THE SENSORS SCREEN WILL BE DISPLAYED AUTOMATICALLY IF THE ENTERED PIPE OD AND/OR TEMPERATURE ARE NOT VALID FOR THE CURRENTLY SELECTED SENSORS.

3.2 Attaching and Connecting the Flow Sensors

- Fit the designated sensors to the pipe using the appropriate guide rails as described in Section 2.2. Take great care to set the separation distance as accurately as possible.
- Connect the red and blue coaxial cables between the sensors and the test instrument, ensuring that the red connector on the instrument is connected to the 'upstream' sensor.

3.3 Taking a Flow Reading

- Once the transducers have been fitted and connected, press the ENTER key on the Summary screen.
- This will take you to the FLOW READING screen via a signal-checking screen.
- Check that the indicated signal strength on the left of the screen is at least 2 bars (ideally 3 or 4). If less than 2 bars are shown it indicates there could be a problem with the transducer spacing, alignment or connections; or it could be due to an application problem.
- The Q value indicates the signal quality and should have a value of 60% or greater. Signal Q is a mixture of the Signal to Noise Ratio (SNR) and signal timing accuracy. This is the best measure of system performance.

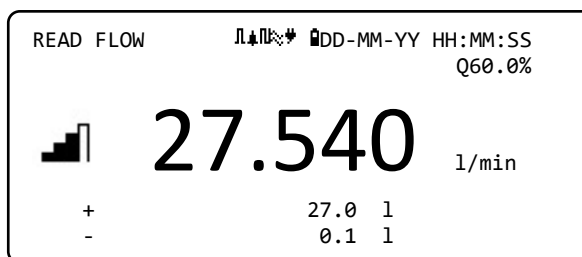

The *Read Flow* screen is used most frequently during normal monitoring operation. It shows the instantaneous fluid flow together with totalised values (when enabled).

If the flow reading exceeds a value of +/-99999 in the selected units then the display will change to exponential (or scientific) notation. This is used in Microsoft™ Excel™ and many other software packages. For example, if the display reads 1.0109E5 l/min, this represents 101,090 l/min (1.0109 × 100,000). Note the number of zeros in the multiplier corresponds to the number following the E on the display. Alternatively, you may select another unit by pressing the **UNITS** (7) key. With units of l/sec, the previous example would read 1684.8 l/sec, hence scientific notation would not be required.

There are no limitations on the use of these larger flow values with regards to logging of data and setting the current and digital outputs. Values are automatically saved in scientific form in any case.

3.4 Flow / Energy / Velocity Monitoring

From the READ FLOW, READ ENERGY or VELOCITY screen you can:

- Switch to the Read Energy display by pressing key 9.
- Switch to the Read Velocity display by pressing key 4.
- Switch back to the Read Flow display by pressing key 8.
- Switch between valid screens every 10 seconds by briefly pressing key 0. Pressing 0, 4, 8 or 9 stops this action.
- Enter the zero-flow screen by a long press of the 0 key.
- Change the display units by pressing key 7.

3.5 Total Flows

The basic measurement indicated on the READ FLOW screen is the instantaneous flow rate, which in some applications may vary over a period of time. Average flow rates are therefore often required in order to get a better understanding of an application’s true performance. This is simply achieved by noting the total flow over a specific period (for example 30-60 minutes) and then calculating the average flow rate over that period of time. BY default, the READ FLOW screen shows both the forward and reverse flow totals.

To change the totals display:

1. From the *Main* menu, use the Up and Down scroll keys to select **Setup Instrument**. Press the ENTER Key.
2. Use the UP/DOWN arrow keys to select **Primary Flow**; press the ENTER Key. The Primary Flow screen is displayed.
3. Select **Display Total** and press the ENTER key. Use the UP/DOWN arrow keys to scroll through the available options: *Both / None / Fwd Total / Rev Total*.
4. With the required display option selected, press the ENTER key.
5. Select Exit and press the ENTER key to return to the *Options* menu.
6. Select **Exit** and press the ENTER key to return to the *MAIN* menu.

Options	↕	DD-MM-YY HH:MM:SS
System..		OK
Power..		OK
Output..		OK
Heat-Meter..		OK
Logger..		OK
→Primary Flow..		OK

Primary Flow Se	↕	DD-MM-YY HH:MM:SS
→Display Total		Both
Damping Mode		Fixed
Damping Time		10 sec
Signal-loss Timeout		3 sec
Flow Direction		Normal
Exit		

3.5.1 Calculating the Average Flow or Power

To calculate the average flow, wait for the allotted monitoring period to expire then divide the indicated total volume or energy by the time taken. This will give you the average flow in m/s, gals/hour or whatever units you select. Follow the same procedure for average power, taking note of the issue below.

Note that in a bi-directional flow situation you must calculate the difference between the indicated positive and negative flow totals before carrying out the average flow rate calculation.

NOTE: IF FLOW IS REVERSED, THEN NORMALLY ENERGY MIGHT BE CONSIDERED REVERSED, HOWEVER, AS THE SYSTEMS UNDER MEASUREMENT DO NOT BEHAVE IN THIS WAY, WHEN FLOW IS REVERSED, THE POWER IS SET TO ZERO, IRRESPECTIVE OF THE MAGNITUDE OF FLOW. THE PERIOD OF FLOW REVERSAL WOULD HAVE TO BE TAKEN INTO ACCOUNT IF AN AVERAGE POWER IS CALCULATED.

3.5.2 Resetting Totals

- From the *MAIN* menu, use the Up and Down arrow keys to select **Setup Instrument**. Press the ENTER Key. With **System** selected in the *Options* menu, press the ENTER Key.

Alternatively, from a *Read Flow/Velocity/Energy* screen, press the SYSTEM key (2). The *System Settings* menu is displayed.

System Settings		DD-MM-YY	HH:MM:SS
Back-light Timeout	60		sec
Audible keypress	On		
Set Date & Time..			
Display Total	Both		
→Reset Totals..			
Damping Mode	Fixed		

- Select **Reset Totals..** and press the ENTER key.
- Enter the code 71360. The *Reset Total* screen is displayed.
- Set the reset values for *Energy Total*, *Fwd Volume Total* and *Rev Volume Total* as required. The totals can be set to any value, but most commonly the reset value will be zero.

Reset Total		DD-MM-YY	HH:MM:SS
Set Energy Total	0		kJ
→Set Fwd Volume Total	0		l
Set Rev Volume Total	0		l
Reset Energy..			
Reset Volume..			
Exit			

- Select **Reset Energy** or **Reset Volume**.
- Select **Yes** to confirm the action (or **No** to cancel).
- If Yes was selected, the total will be reset and the word “Done..” appears against the quantity that was reset.
- Reset the remaining quantity (*Energy* or *Volume*) if required.
- Select **Exit** and press the ENTER key to return to the *MAIN* menu.

4 MANAGING NAMED SITES

Setting up the Portaflow system using the Quick Start method described in the previous chapter is the recommended method to use in a 'one-off' situation.

If you have several site locations that you want to monitor on a frequent basis it is better to set up a named 'Site' to store the installation details, such as pipe dimensions, material and other setting that are required to set-up the Portaflow system. These can then be recalled later when revisiting a particular location.

4.1 View/Edit Site Data

Use the **View/Edit Site Data** command on the *MAIN* Menu to display the View/Edit Site menu. This allows you to:

- Manage site names.
The instrument can store up to 12 sites, the first site is reserved for the default *QuickStart* site and cannot be renamed; subsequent sites are initially named *Site01* through to *Site11*.
- Edit key parameters such as pipe outside diameter and wall thickness.
- Change calibration factors including Cut-off Velocity and Roughness Factor.

```
PF333HAB MAIN  [F4]  DD-MM-YY HH:MM:SS
Quick start..
->View/Edit Site Data..
Setup Instrument..
Data Logger..
Read Flow..
Read Energy..
```

```
View/Edit Site  [F4]  DD-MM-YY HH:MM:SS
P Choose from list of sites..
Add new site..
Site name..           QuickStart
Pipe outside diameter 114.30 mm
Pipe circumference    359.08 mm
Pipe wall material    Plastic
Pipe wall thickness   8.00 mm
Lining material       None
Pipe lining thickness 0.0 mm
Sensor set A-ST
Sensor mode Reflex
Fluid type Water
Fluid temperature     14.0 °C
Cutoff Velocity       0.010 m/sec
Roughness factor      0.0150 mm
Zero Flow Velocity    -0.0140 m/sec
Zero Flow Offset      -5.1437 l/min
Calibration factor    1.000
RTD Settings..
Read flow using selected sensor..
Read flow using recommended sensor..
Delete this site..
Exit
```

4.2 Selecting an Existing Site

1. Select **View / Edit Site Data** from the MAIN MENU.
2. Select **Choose from list of sites**.
3. Use the UP/DOWN arrows to select the required site, then press the ENTER key. The stored parameters are retrieved from memory and displayed on-screen.
4. Scroll down through the menu list and enter or change any data that might have changed since the last time the site was accessed (see *Managing Named Sites*, page 30). Changes are saved automatically only when entering the READ FLOW screen.

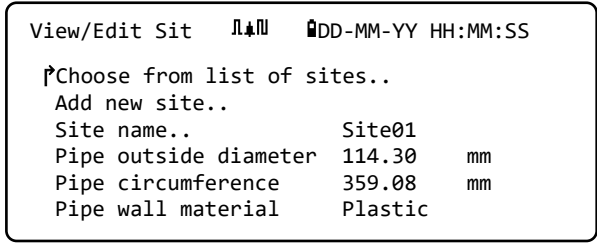

5. Select **Read flow using selected sensor** or **Read flow using recommended sensor**.

6. The *Summary* screen now displays some of the parameters you may have entered and informs you of the type of sensor to be used, the mode of operation and the distance to set up between the sensors.
 In this example, it recommends type A-ST (A standard) sensors operating in the 'Reflex' mode spaced at 67.4mm apart.

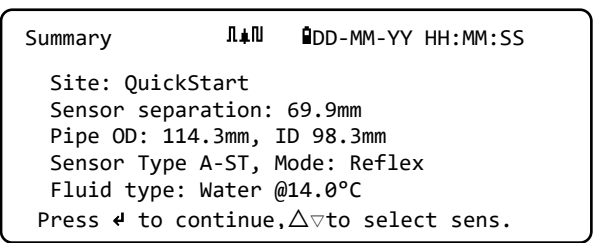

NOTE: THE SENSORS SCREEN CAN BE ENTERED BY PRESSING EITHER OF THE SCROLL KEYS. THIS ALLOWS THE TYPE AND MODE OF THE SENSORS BEING USED TO BE SELECTED. ENSURE THAT THE SENSORS ARE CONNECTED PROPERLY (SEE PAGE 8).

7. Press the ENTER key to display the *READ FLOW* screen.

NOTE: DO NOT PRESS THE ENTER KEY UNTIL THE TRANSDUCERS ARE FITTED AND CONNECTED TO THE INSTRUMENT.

4.3 Adding a New Site

To add a new site:

1. Select **View / Edit Site Data** from the *MAIN* menu.
2. Select **Add new site**.
3. You are prompted to edit the Site name. Sites are initially named *Site01* through to *Site11* using the numeric keypad in a Multi-Press mode.

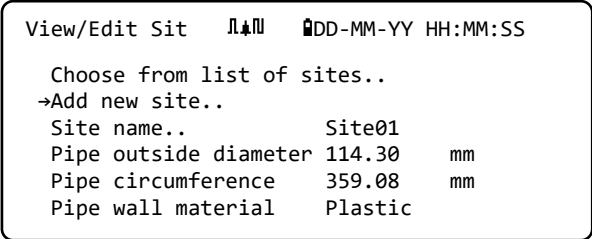

Each key represents three or more characters.

For example, “1” represents the characters

ABCabc1. Repeatedly press the same key to cycle through the characters for that key. Pausing for a brief period of time will automatically select the current character in the cycle. Punctuation and special characters (such as “\$”, “-

“,”,”.”,”_”,”.”,”#,”~”, and more) can be accessed via the “0” key, and spaces via the “9” key. Site names are limited to 8 characters, must contain no punctuation, and be unique.

4. A new site with the name supplied will be created using default values for all parameters.

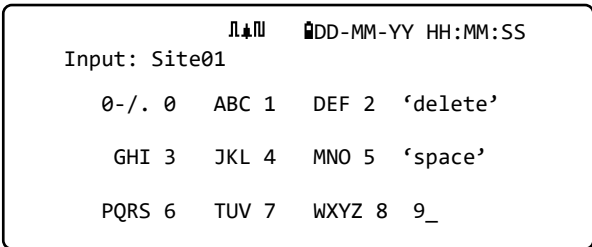

NOTE: THIS MENU ALLOWS YOU TO CHOOSE A SENSOR SET, UNLIKE THE QUICK START WIZARD WHICH RECOMMENDS THE SENSOR SET TO USE. IF YOU ENTER AN INAPPROPRIATE SENSOR SET IN THIS MENU YOU WILL BE PRESENTED WITH AN ERROR MESSAGE LATER WHEN YOU GO TO THE SENSOR SEPARATION SCREEN AND YOU WILL BE UNABLE TO START READING FLOW.

4.4 Changing a Site Name

To change a site name, select **Choose from list of sites** from the **View / Edit Site Data** menu. Select the required site from the displayed list of current sites. Select the site name and press ENTER. You will be prompted to confirm your choice to modify the name or exit the process. When changing the name, the same rules apply for the name as when adding a new site.

4.5 Editing Site Data

1. Having selected the appropriate site (see page 31), scroll through the menu list and enter/change the pipe, sensor and fluid parameters.

- Pipe outside diameter
- Pipe circumference
- Pipe wall material
- Pipe wall thickness
- Lining material
- Pipe lining thickness
- Sensor set
- Sensor mode
- Fluid type
- Fluid temperature

View/Edit Sit		DD-MM-YY HH:MM:SS
↑ Choose from list of sites..		
Add new site..		
Site name..	QuickStart	
Pipe outside diameter	114.30	mm
Pipe circumference	359.08	mm
Pipe wall material	Plastic	
Pipe wall thickness	8.00	mm
Lining material	None	
Pipe lining thickness	0.0	mm
Sensor set	A-ST	
Sensor mode	Reflex	
Fluid type	Water	
Fluid temperature	14.0	°C
Cutoff Velocity	0.010	m/sec
Roughness factor	0.0150	mm
Zero Flow Velocity	-0.0140	m/sec
Zero Flow Offset	-5.1437	l/min
Calibration factor	1.000	
RTD Settings..		
Read flow using selected sensor..		
Read flow using recommended sensor..		
Delete this site..		
Exit		

NOTE: IF YOU SELECT A DIFFERENT SENSOR SET (E.G. A-ST) WHEN ENTERING NEW SITE DATA YOU COULD RECEIVE AN “INVALID” ERROR MESSAGE IF THE PREVIOUS SENSOR SET WAS OPERATING AT A TEMPERATURE ABOVE 135°C. IF THIS OCCURS, IGNORE THE WARNING AS IT WILL DISAPPEAR WHEN YOU ENTER A TEMPERATURE IN THE CORRECT RANGE FOR NEW SENSORS.

2. When all the data is correct, choose one of the following options:

- a. Select **RTD Settings** to view the RTD configuration (*PF333 models only*).
- b. Select **Read flow with selected sensors** to continue fitting the transducers you have specified in the site description and then open the FLOW READING screen.
- c. Select **Read flow with recommended sensors** to view the optimum sensors and configuration for the parameters you have specified in the site description.
- d. Select **Delete this site** to delete the site from the site list. You are prompted to confirm the action. Select **Yes** to continue with the deletion or **No** to cancel the action and keep the site.
Press the ENTER key to continue.
- e. Select **Exit** to return to the *MAIN* menu.

4.6 Changing Calibration Parameters

The Portaflow is fully calibrated before it leaves the factory however, the following adjustments are provided to allow you to further ‘fine tune’ your instrument to suit local conditions and the user’s application where necessary. Apart from the zero-flow offset adjustment, these are normally carried out only where the instrument is to be used in a permanent or semi-permanent location.

4.6.1 Adjusting the Zero Cutoff

This adjustment allows you to set a minimum flow rate (m/s) below which the instrument will indicate ‘0’. The default setting is 0.1 m/s but you may adjust this value if required.

1. Select **View / Edit Site Data** from the MAIN MENU.
2. Use the UP/DOWN arrow keys to select **Cutoff Velocity**. Press the ENTER key.
3. Edit the value as required and then press the ENTER key.
4. Scroll down to select **Exit** and press the ENTER key to return to the **View/Edit Site Data** menu.

4.6.2 Adjusting the Zero-Flow Offset (ZFO)

The Portaflow unit operates by comparing the time taken to send an ultrasonic signal between two transducers in either direction. A zero-flow offset adjustment is provided to compensate for any inherent differences between the two sensors, noise pick-up, internal pipe conditions etc. It can be used to ‘zero’ the flow indication under no-flow conditions.

The sign of the zero-flow volumetric reading or the velocity is always the same irrespective of the direction of flow because the ZFO is a function of the sensor match. If the ZFO offset is significant, and the sensor leads are reversed, one of the following procedures must be followed again to ensure continued accurate results.

There are two methods for setting the zero-flow offset: the in-built Zero Flow Offset feature (ZFO) or by manual intervention.

Method 1 – Using the Zero Flow Offset (ZFO)

Using this method, the unit runs for a period of time and collates the data and averages it over this period. The zero-flow cut-off is automatically removed while running the test and returned to its previous value afterwards. Likewise, it will remove any existing ZFO automatically and either replace or restore it. To use the ZFO feature:

1. Stop the liquid flow.
2. With the instrument in FLOW READING mode, press and hold the 0 (zero) key for at least two seconds.
3. In the **Set Zero Flow** screen, set the damping time and the measurement time. The recommended measurement time should be in the region of 60 to 120 seconds, but much longer periods are possible if significant drift in measurements have been noted over a longer period.

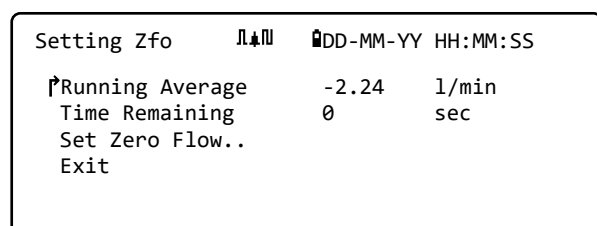

4. Select **Continue..**
5. On the **Setting Zfo** screen, the **Running Average** is updated every second. When the measurement has completed, a loud ½ second beep will be heard and the countdown will stop.
6. You may now select **Set Zero Flow..** if desired. It should be noted that you may select this setting at any time before the measurement is complete if you are satisfied that the average reading is sufficiently accurate.

Method 2. - Manual Intervention

To manually adjust the zero flow offset:

1. From the main menu.
2. Select View/Edit Site Data.
3. Use the UP/DOWN arrow keys to select **Cutoff Velocity** and set the figure to 0.
4. Continue onto the flow reading screen.
5. Stop the liquid flow. Press the **Velocity** function key and observe the reading (m/s). Any reading other than 0.000 indicates an offset error and in practice this will typically be in the range ± 0.005 m/s (possibly higher with smaller diameter pipes). If a greater figure is shown, it is worth calibrating the offset to obtain a more accurate result. Continue as follows:
6. Press the ENTER key and select '**Yes**' to confirm that you want to exit the flow screen. The Main Menu is displayed.
7. Select View / Edit Site Data.
8. Use the UP/DOWN arrow keys to select **Zero-Flow Velocity**. Press the ENTER key.
9. Edit the value as required and then press the ENTER key.
10. Reapply the factory Cutoff Velocity 0.1 m/sec
11. Scroll down to select **Read flow using selected sensor** and press the ENTER key.
12. Check that the UF3300 is now reading zero correctly.
13. Restart the fluid flow.

4.6.3 Adjusting the Calibration Factor

IMPORTANT: USE THIS FACILITY WITH CARE & ONLY WHERE NECESSARY

THE PORTAFLOW UNIT IS FULLY CALIBRATED BEFORE LEAVING THE FACTORY AND UNDER NORMAL CIRCUMSTANCES DOES NOT REQUIRE FURTHER CALIBRATION WHEN USED ON SITE.

THIS FACILITY CAN BE USED TO CORRECT THE FLOW INDICATION WHERE UNAVOIDABLE ERRORS OCCUR DUE TO THE LACK OF A STRAIGHT PIPE OR WHERE THE SENSORS ARE FORCED TO BE FITTED CLOSE TO THE PIPE-END, VALVE, JUNCTION ETC.

ANY ADJUSTMENT MUST BE MADE USING A REFERENCE FLOWMETER FITTED IN THE SYSTEM.

With the system running:

1. Stop the Portaflow's totaliser and zero it (see page 29).
2. Start the Portaflow reading flow. Use the Portaflow totaliser to measure the total flow over a 30-60 minute period, and note the total flow indicated by the reference flow meter over the same period.
3. Calculate the % error between the Portaflow and reference meters. If the error is greater than $\pm 1\%$ calibrate the Portaflow as detailed below.
4. Press the ENTER key and select 'Yes' to confirm that you want to exit the *Read Flow* screen. The *Main Menu* is displayed.
5. Select **View / Edit Site Data**.
6. Use the UP/DOWN arrow keys to select **Calibration factor**. Press the ENTER key.
7. Change the calibration factor according to the error calculated in step 3. For example, if the Portaflow was reading 1% high, decrease the Calibration factor value by approximate this amount. Since that start value is 1.00, the calibration value should be 0.99. Conversely, if the reading is 1% low then increase the calibration factor to 1.01.
8. Press the ENTER key to apply the change and return to the *View/Edit Site Data* menu.
9. Scroll down to select **Read flow using selected sensor** and press the ENTER key.
10. Check the flow measurement against the reference flow meter again.

4.6.4 Adjusting the Roughness Factor

The roughness factor compensates for the condition of the internal pipe wall, as a rough surface will cause turbulence and effect the flow profile of the liquid. The unit of roughness is mm or inches, depending on the current setting. The value represents the worst height difference between a pit and a peak in the pipe wall. In most situations, it is not possible to inspect the pipe internally and the true condition is not known. In these circumstances experience has shown that the following values can be used for pipes in good condition:

Pipe Material	Roughness Factor
Non-ferrous metal Glass Plastics Light metal	0.01 mm
Drawn steel pipes: • Fine planed, polished surface • Plane surface • Rough planed surface	0.01 mm
Welded steel pipes, new: • Long usage, cleaned • Lightly and evenly rusted • Heavily encrusted	0.1 mm
Cast iron pipes: • Bitumen lining • New, without lining • Rusted / Encrusted	1.0 mm

When a new site is added to the system a default value for roughness will be set depending on the pipe material.

With the system running in FLOW READING mode:

1. Press the ENTER key and select 'Yes' to confirm that you want to exit the *Read Flow* screen. The *Main Menu* is displayed.
2. Select **View / Edit Site Data**.
3. Use the UP/DOWN arrow keys to select **Roughness factor**. Press the ENTER key.
4. Change the roughness factor according to the pipe material and condition as described above.
5. Press the ENTER key to apply the change and return to the *View/Edit Site Data* menu.
6. Scroll down to select **Read flow using selected sensor** and press the ENTER key to return to the Read Flow screen.

4.6.5 Adjusting the Damping Factor

By averaging-out the flow rate over several seconds, the Damping factor can be used to smooth out rapid changes in flow rate and prevent large fluctuations in the displayed flow value. It has a range of 0 to 50 s, with a default setting of 10s. The damping time is defined as the time required for a step change in flow to reach 98.2% of its final value.

1. From the *Main* menu, use the Up and Down scroll keys to select **Setup Instrument**. Press the ENTER Key. With **System** or **Primary Flow** selected in the *Options* menu, press the ENTER Key.

Alternatively, from a *Read Flow/Velocity/Energy* screen, press the SYSTEM key (2). The *System Settings* menu is displayed.

2. Use the UP/DOWN arrow keys to select **Damping Time**. Press the ENTER key.
3. Enter the value of the Damping Time (0 - 50 s) as required to remove any unwanted display fluctuations. Increasing the value applies a greater smoothing effect.
4. Press the ENTER key to apply the selection. Not all values of damping in the range are valid. The instrument will set the damping time to the nearest valid time, which may not be exactly as entered. Note that zero seconds is a totally undamped response.
5. Select the desired Damping Mode. Fixed mode strictly follows the damping period as initially described in this paragraph. Dynamic mode switches off damping if the magnitude of change in flow velocity exceeds a certain predefined value. Once the change in velocity drops below this threshold, damping time is reset to the value selected.
6. Return to the **System** menu.
7. Select **Exit** and press the ENTER key to return to the Main menu.

NOTE: IF THE DAMPING FACTOR IS SET HIGH THE VALUE DISPLAYED MAY APPEAR STABLE BUT FLOW READINGS MAY RESPOND VERY SLOWLY TO LARGE STEP CHANGES. IN THIS CASE, CONSIDER USING DYNAMIC DAMPING.

5 LOGGING FUNCTIONS

NOTE: THIS CHAPTER ONLY APPLIES TO PF333 MODELS. PF222 MODELS DO NOT HAVE LOGGING CAPABILITIES.

This procedure shows you how to set up a basic logging session under manual start/stop control. Logged data is saved to the instrument’s memory and can be copied to a USB flash drive as a CSV (Comma Separated Values) file at a later time. Date, Time, Flow Rate, Forward (+) and Reverse (-) totals, Velocity, Signal Q(quality), SNR and general signal status are logged automatically. If the unit has a Heatmeter fitted, the Hot, Cold and the Temperature difference values are logged in addition to instantaneous power, and a total energy figure. Logging writes to internal memory, which may then be copied to a USB flash drive at a later date.

5.1 Manual Logging

This procedure assumes that the Portaflow unit has been correctly installed and is operating in the FLOW READING mode.

1. Check that the indicated flow units are the same as those you want to appear on the logger output (e.g. l/min).
2. Press the Logger function key (1) to access the *Real Time Logger* screen.
3. Check that the site name is correct and make a note of the filename.
4. Select **Logging interval** and enter the required period (e.g. 5 minutes). Note that the minimum logging period is 5 seconds and the maximum is 28 days (4 weeks).

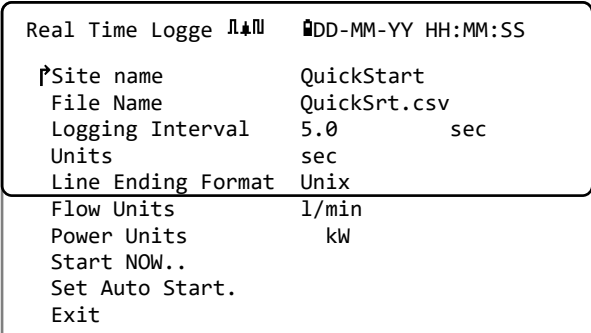

5. To start logging immediately, select **Start NOW.**

NOTE: WHEN LOGGING IS IN PROGRESS, THIS MENU ITEM BECOMES STOP NOW. USE THIS COMMAND TO STOP LOGGING ACTIVITY MANUALLY.

6. If a log already exists for the selected site, the current run will be appended to the existing data. Each time a new run is started, a new header will be observed in the CSV file.

5.2 Scheduling Logging

To set a schedule for data logging:

1. Select **Set Auto Start** on the *Real Time Logger* screen.
2. Select **Start Date & Time**. A flashing cursor will appear under the first date number. Enter the date and time sequence in *dd-mm-yy:hh-mm-ss* or *mm-dd-yy:hh-mm-ss* order depending on the current time and date format. Then press the ENTER key.

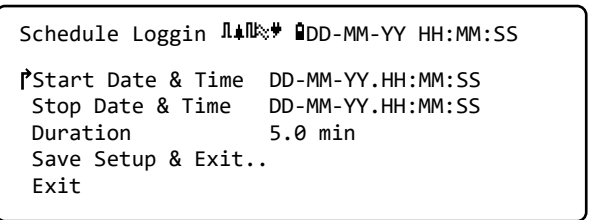

3. Select **Stop Date & Time** in the same way.

NOTE THIS MUST BE LATER THAN THE START TIME AND PROVIDE AT LEAST A TWO MINUTE BUFFER WHEN EXITING THE SCHEDULE LOG SCREEN.

4. *Duration* shows the logging period calculated from the Start and Stop times.
5. Select **Save Setup & Exit** and press the ENTER key to return to the *Real Time Logger* screen.

5.3 Stopping Logging

From the FLOW READING screen, press the Logger function key to access the REAL TIME LOGGER screen.

1. Press the Logger function key (1) to access the *Real Time Logger* screen.

2. Select **STOP NOW** to cease logging.

NOTE: THE STOP NOW OPTION REPLACES THE START NOW COMMAND WHEN LOGGING IS ACTIVE.

3. Confirm the action when prompted.
4. Select **Exit** to return to the READ FLOW screen.

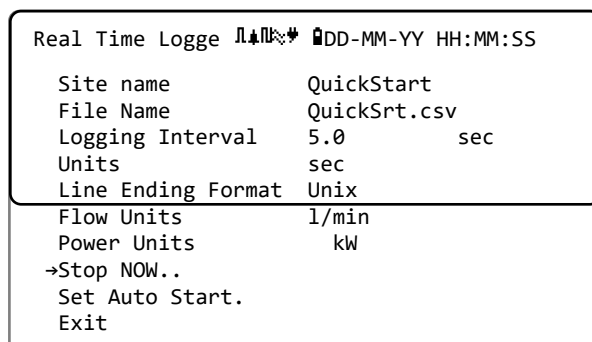

NOTE: THE LOGGED DATA WILL REMAIN STORED IN THE INSTRUMENT’S MEMORY AND CAN BE ACCESSED AT ANY TIME AS DESCRIBED BELOW.

5.4 Copying Logged Data to a USB Memory Stick

This procedure describes how to copy a stored log file to a USB memory stick.

1. Connect a suitable USB memory stick to the Portaflow USB socket (see page 8).
2. Access the *MAIN* menu.
3. Select **Data Logger** from the *MAIN* menu.
4. Select **Choose from list of sites** and select the name of the site to download.
5. When you are ready to begin downloading the log select **Copy log**.
6. Logged data for the selected site will now be copied to the USB memory stick.
7. Upon completion select **Exit** to return to the *MAIN* menu.

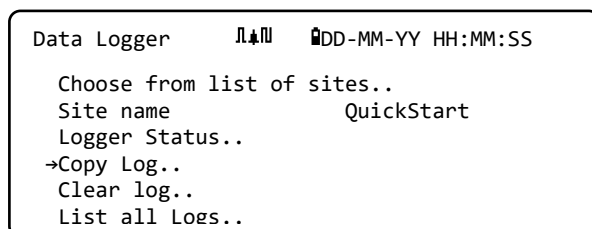

NOTE: The logger uses an MS-DOS compatible 8.3 file name format for the CSV files. It may be possible that the name of the file is not exactly as you expect. For example, the Quickstart site is saved in a file called QUICKSRT.CSV. Also note that for very large files the copy process may take some time, so please be patient. If the copy process take > 2 minutes, the unit may abort the copy. In this case, please contact your distributor or Micronics Ltd.

5.5 Clearing Log Files

1. Access the *MAIN* menu.
2. Select **Data Logger** from the *MAIN* menu.
3. Select **Choose from list of sites** and select the name of the site to clear.
4. Delete logged data for the selected site by selecting **Clear log**.
5. Upon completion select **Exit** to return to the *MAIN* menu.

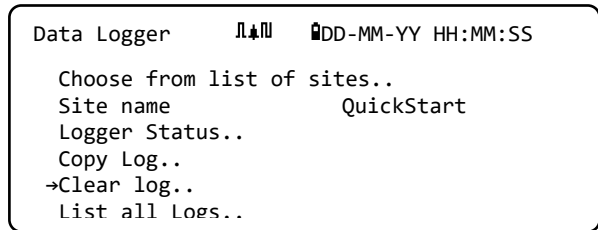

5.6 Logger Status

To view the current setup, memory usage and availability for data logging:

1. Access the *MAIN* menu.
2. Select **Data Logger** from the *MAIN* menu.
3. Select **Logger Status** (also accessed from the *Options* screen by selecting **Logger..**).

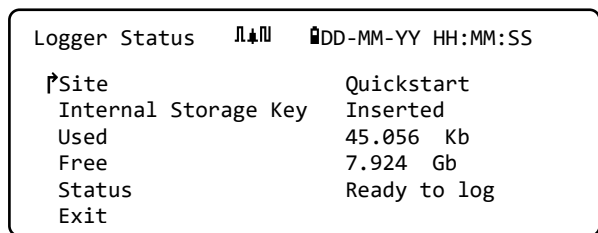

6 OUTPUTS

6.1 Current Loop Setup

The Portaflow allows you to set a current output between zero and 24mA. Standard ranges include 4-20mA, 0-16mA and 0-20mA. The current range can be used to represent only positive flow, or negative flow ranging into positive flow, or simply negative flows.

In addition to this, you may set an out-of-band value to represent an error current. For example, with a 4-20mA loop, it is common to use either 2.5mA or 22.5mA as an error current. Nevertheless, you may set the error current to be any value that is not within the valid measurement range. An error current can be used to indicate a number of causes including: exceeding a predetermined value, being under a predetermined value, being out-of-bounds (value is below the minimum or above the maximum), or a loss-of-signal condition. In addition, inhibiting the generation of an error current can be achieved by selecting the no error condition.

NOTE: THE 4-20MA CURRENT OUTPUT IS SET IN HARDWARE TO BE ACCURATE TO +/- 0.3%. IF YOU REQUIRE GREATER ACCURACY THAN THIS OR IF THERE ARE KNOWN INACCURACIES IN THE MEASUREMENT SYSTEM WHICH MAY REQUIRE COMPENSATION, THEN CALIBRATION VALUES MAY BE SET AT THE LOW AND HIGH ENDS OF THE CURRENT LOOP RANGE. THESE VALUES ARE LINEARLY INTERPOLATED OVER THE RANGE OF THE CURRENT LOOP.

The default current loop setting is OFF.

To change any of these settings:

1. From the MAIN menu, use the Up and Down scroll keys to select **Setup Instrument**. Press the ENTER Key. With **Output** selected in the *Options* menu, press the ENTER Key.

```

Output Board Se  ⏏⏏⏏  DD-MM-YY HH:MM:SS
┆Current Loop Setup..
Digital Device 1 Setup.  ⏏
Digital Device 2 Setup.  ⏏
Digital Device 3 Setup.  ⏏
Exit..
    
```

Alternatively, from a *Read Flow/Velocity/Energy* screen, press the OUTPUTS key (3). The *Output Board* menu is displayed.

2. Use the UP/DOWN arrow keys to select **Current Loop Setup**. Press the ENTER key. The *Current Loop Setup* menu is displayed.
3. Edit the settings as required (see next page). The 4-20mA can be set to represent a particular flow range. It is also possible to enter a negative figure for the minimum output and this would enable a reverse flow to be monitored.

```

Current Loop Se      DD-MM-YY HH:MM:SS
┆Current Loop Status  Off
Measurement Source   Flow
Value at min output   0 l/min
Min output current    4.00 mA
Calibrate min current 0.00 mA
Value at max output   1000 l/min
Max output current    20.00 mA
Calibrate max current 0.00 mA
Output error current  0.00 mA
Error Current Source  None
Alarm trigger point   500 l/min
Save Setup & Exit..
Exit
    
```

Setting	Flow Options (default)	Power Options (default)
Current Loop Status	Off/On	
Measurement Source	Flow	Power
Value at min output Metric Imperial US Imperial	0 l/min 0 gal/min 0 US gal/min	0 kW 0 BTU/hr 0 BTU/hr
Min output current	0.00 mA	
Calibrate min current	0.00 mA	
Value at max output Metric Imperial US Imperial	2000 l/min 439.939 gal/min 528.344 USgal/min	0.033333 kW 113.738 BTU/hr 113.738 BTU/hr
Max output current	24.00 mA	
Calibrate max current	0.00 mA	
Output error current	2.50 mA	
Error Current Source	Exceeds Value/Under Value/Signal Loss/Out of Bounds/None	
Alarm trigger point Metric Imperial US Imperial	2000 l/min 439.939 gal/min 528.344 USgal/min	0.033333 kW 113.738 BTU/hr 113.738 BTU/hr

6.1.1 Example

A simple example of a current output representing a specific range with errors and alarm is shown below:

- Current Range: 4-20mA
- Flow: @4mA, 0 l/min; @20mA, 500 l/min
- Error current: 2.5 mA
- Error source: Exceeds value
- Alarm trigger point: 450 l/min

To implement this example:

1. Set **Current Loop Status** to On
2. Set **Measurement Source** to Flow
3. Set **Value at min output** to 0 l/min
4. Set **Min Output Current** to 4.0mA
5. Set **Calibrate min current** to 0mA
6. Set **Value at max output** to 500 l/min
7. Set **Max output current** to 20mA
8. Set **Calibrate max current** to 0mA

9. Set **Error Current Source** to *Exceeds Value*
10. Set **Alarm trigger point** to 450 l/min
11. Press **Save** and **Exit** to save the setup.
12. Read flow and take a reading on the user's measuring equipment with the flow turned off. It should show zero as measured by your system (@4.0mA). If it does not, then it could be that the equipment measuring the output is inaccurate. As long as the error is reasonably linear, it can be trimmed out using the *Calibrate min current* and *Calibrate max current*.
13. With flow turned off, adjust the **Calibrate min current** until the output equipment reads exactly zero.
14. Next, run with maximum flow according to the flow-meter. Note the equipment reading. Adjust the **Calibrate max current** until the output equipment reads the same flow as the meter.

6.1.2 Converting the Measured Current to Flow Rate

Assume the maximum flow rate is F_{max} (l/min) and the minimum flow rate F_{min} is '0' (l/min), as shown below.

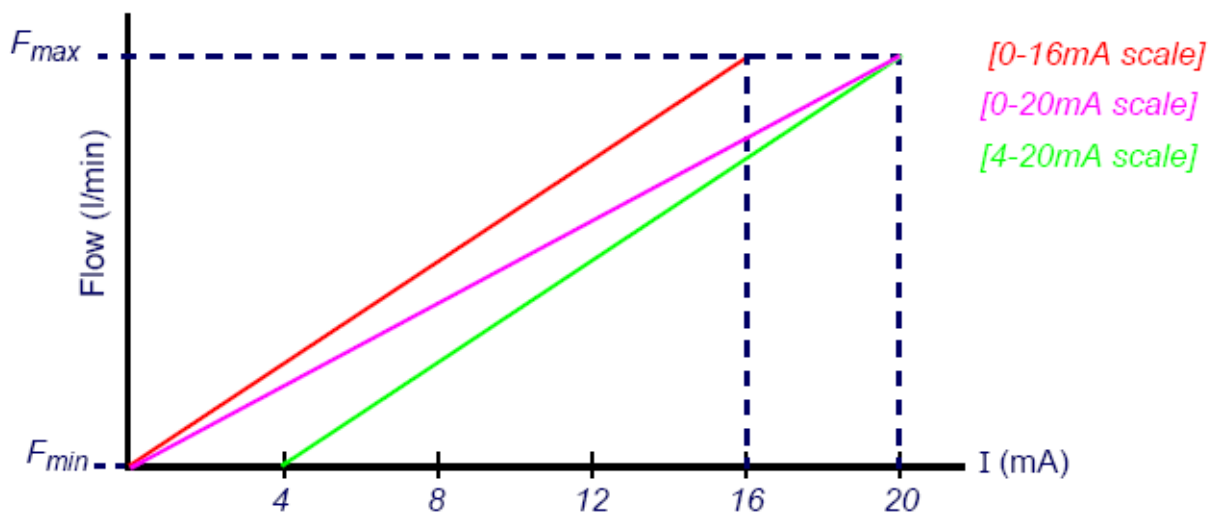

To calculate the flow rate (l/min) for a measured current (mA) then:

0-20mA $Flow\ rate = I \times \frac{(F_{max} - F_{min})}{20} + F_{min}$

0-16mA $Flow\ rate = I \times \frac{(F_{max} - F_{min})}{16} + F_{min}$

4-20mA $Flow\ rate = (I - 4) \times \frac{(F_{max} - F_{min})}{16} + F_{min}$

6.2 Digital Outputs

The three digital outputs can each be set up to operate in one of three modes:

- Pulse Output (set to *Normally Open* or *Normally Closed* contact types)
- Alarm Output (set to trigger on *Rising* or *Falling* conditions)
- Frequency Output (with *High Frequency* and *Low Frequency* settings)

The measurement source can be:

- Volume (not compatible with Frequency Output)
- Flow (not compatible with Pulse Output)
- Energy (not compatible with Frequency Output)
- Power (not compatible with Pulse Output)
- Signal (not compatible with Pulse Output)

There are no limitations on the combinations of these modes and their assignment to each of the three outputs. For example, the digital outputs could be configured as three alarms attached to the same flow reading with different trigger points, or perhaps two alarms – one attached to Volume and one attached to Power – and one frequency output connected to flow.

To configure any of the digital outputs:

1. From the MAIN menu, use the Up and Down scroll keys to select **Setup Instrument**. Press the ENTER Key. With **Output** selected in the *Options* menu, press the ENTER Key.

Alternatively, from a *Read Flow/Velocity/Energy* screen, press the OUTPUTS key (3). The *Output Board* menu is displayed.

2. Use the UP/DOWN arrow keys to select **Digital Device 1/2/3 Setup**. Press the ENTER key. The *Output 1/2/3* menu is displayed.

3. Use the UP/DOWN arrow keys to select **Function**. Press the ENTER key.

```

Output 1      [▲][▼]  [■]DD-MM-YY HH:MM:SS
Function      Pulse Output
Measurement Source  Volume
Continue..
Exit..
  
```

4. Use the UP/DOWN arrow keys to scroll through the output types: **Pulse Output**, **Alarm Output** or **Frequency Output**. With the required output selected, press the ENTER key.

5. Edit the settings as required (see below).

Pulse Output		Alarm Output		Freq. Output	
Setting	Option/default	Setting	Option/default	Setting	Option/default
Quantity Per Pulse	Volume:1.000 m ³ Energy:3600.0kJ	Direction	Rising / Falling	Low Freq.	0 Hz
Pulse Duration	50ms	Activation Level	Volume: 0.5m ³ Flow: 30000 l/min Energy:1800 kJ Power: 2.5kW Signal: 0.5	Low Value	Flow:0.00 l/min Power: 0 kW Signal:0
Contact Type	Normally Open/ Normally Closed	Deactivation Level	Volume 0.475m ³ Flow: 28500 l/min Energy:1710 kJ Power: 2.375 kW Signal: 0.5	High Freq.	200 Hz
				High Value	Flow: 1000.00 l/min Power: 5.00 kW Signal: 1

6.2.1 Pulse Output

Select **Pulse Output** to measure *Volume* or *Energy* and then press **Continue**. Any other selection of Measurement Source will result in an error.

The default pulse width is set to 50ms which represents half of a one pulse cycle. A 50ms pulse width is required for most mechanical counters, but the width can be set as low as 10ms.

Volumetric Pulse

The quantity per pulse is usually set to a value that makes it easy to read an external pulse counter. For example, the value could be 10 litres per pulse, which means that for every 10 litres of fluid measured by the meter, a pulse is generated. If the total rises by 25 litres in a second, two pulses will be generated and the remainder of 5 litres will be held over. If, in the next second, another 25 litres are measured, this will be added to the remainder making a total of 30 litres. This will result in the meter generating 3 pulses.

A minimum idle time equal to the pulse-width, follows the pulse. There is a maximum pulse rate and hence maximum volumetric flow that the pulse output can represent.

For the scenario mentioned above, if the volume per pulse is ϑ and the pulse width is ρ (ms), then the maximum flow rate is $500 \vartheta / \rho$. In the example above, ϑ is 10 l/pulse and ρ is 50 ms, the maximum average flow rate is $500 * 10 / 50 = 100$ l/s. This limit comes from the inability to generate more than 10 pulses per second due to the 50ms pulse width and minimum 50ms idle time. Because each pulse represents 10 litres, the output can only represent 100 l/s.

While this is the maximum average flow, it does not mean that transient flows of greater than this amount cannot be handled. The flow meter can accommodate up to 1000 outstanding pulses. If this amount is exceeded, then an error will be generated. If the flow rate is below the average, the pulse tally can be made up by a burst of pulses.

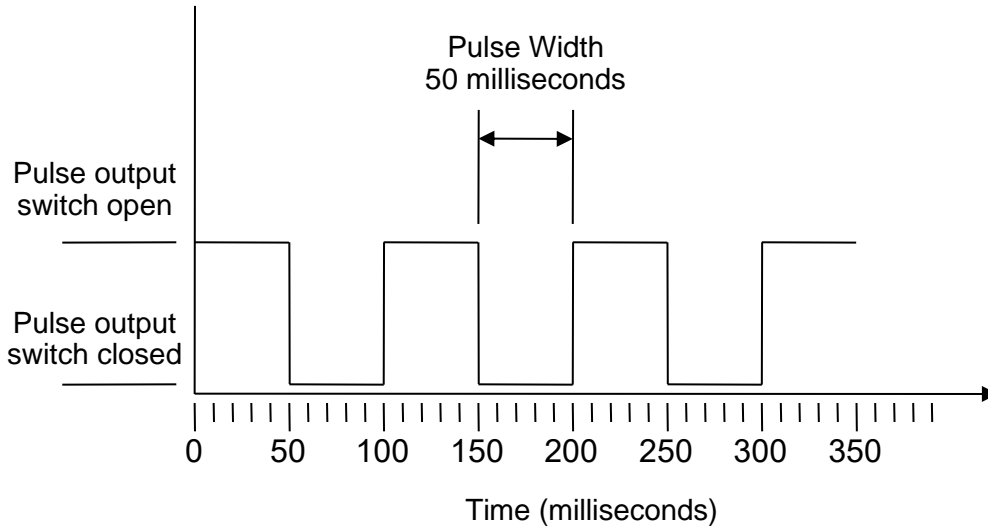

Default Pulse Width

Using our example once again, if the flow rate is 150 l/s, 15 pulses would be required to represent it. Since the flow meter can only generate 10 per second, the other 5 must held as an outstanding count. Since the flow meter can store up to 1000 outstanding pulses, it can tolerate a flow rate of 150 litres/second for 1000/5=200 seconds before an error is generated. At some stage however, the flow rate must drop below 100 litres per second for the outstanding pulse total to be diminished.

Determining a Suitable Volume per Pulse Value

How to calculate a suitable **Volume per pulse** value from **Maximum flow rate** and **Pulse width** (Imperial)

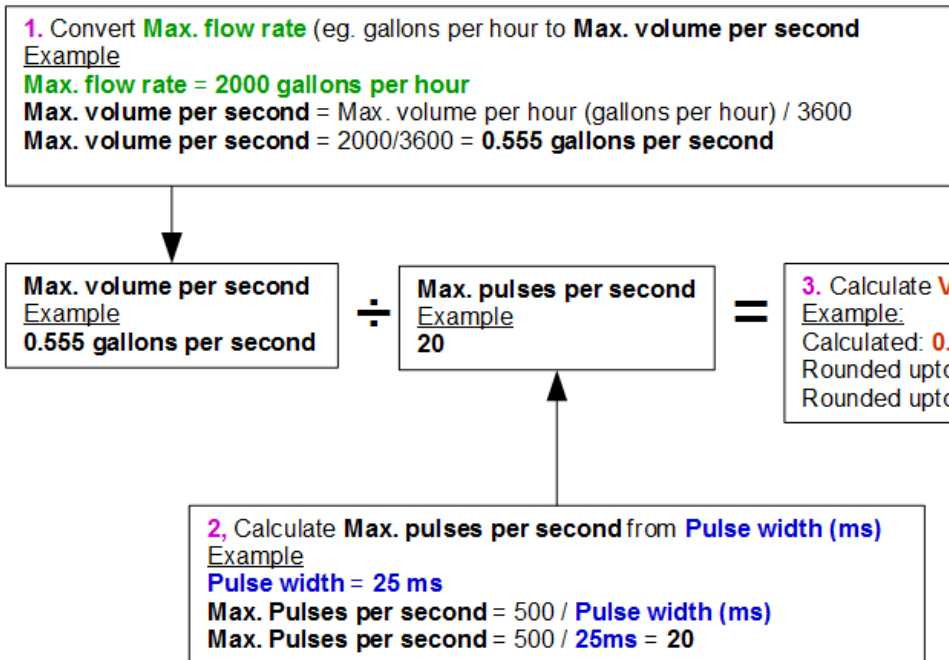

Energy Pulse (Portaflow 333 only)

Each pulse represents an amount of energy, for example 1kWh. With a limitation on the maximum pulse rate (as described in the previous section) a larger unit of energy per pulse or a smaller pulse width may be required to represent the range of possible values.

How to calculate a suitable **Energy per pulse** value from **Maximum power** and **Pulse width** (Imperial)

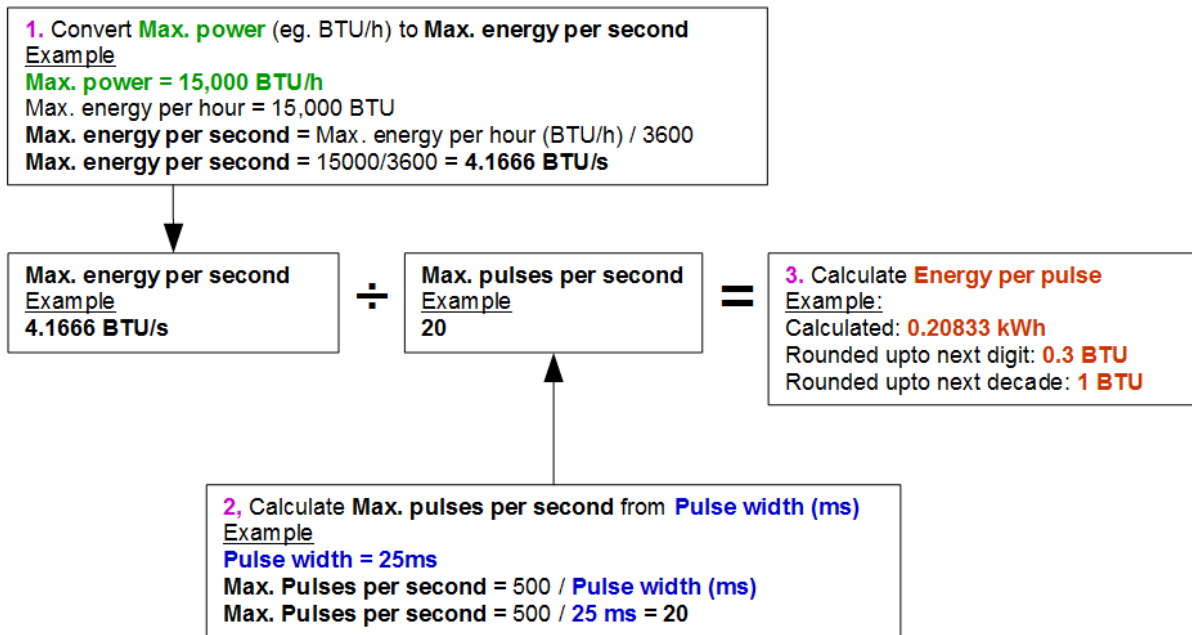

How to calculate a suitable **Energy per pulse** value from **Maximum power** and **Pulse width** (Metric)

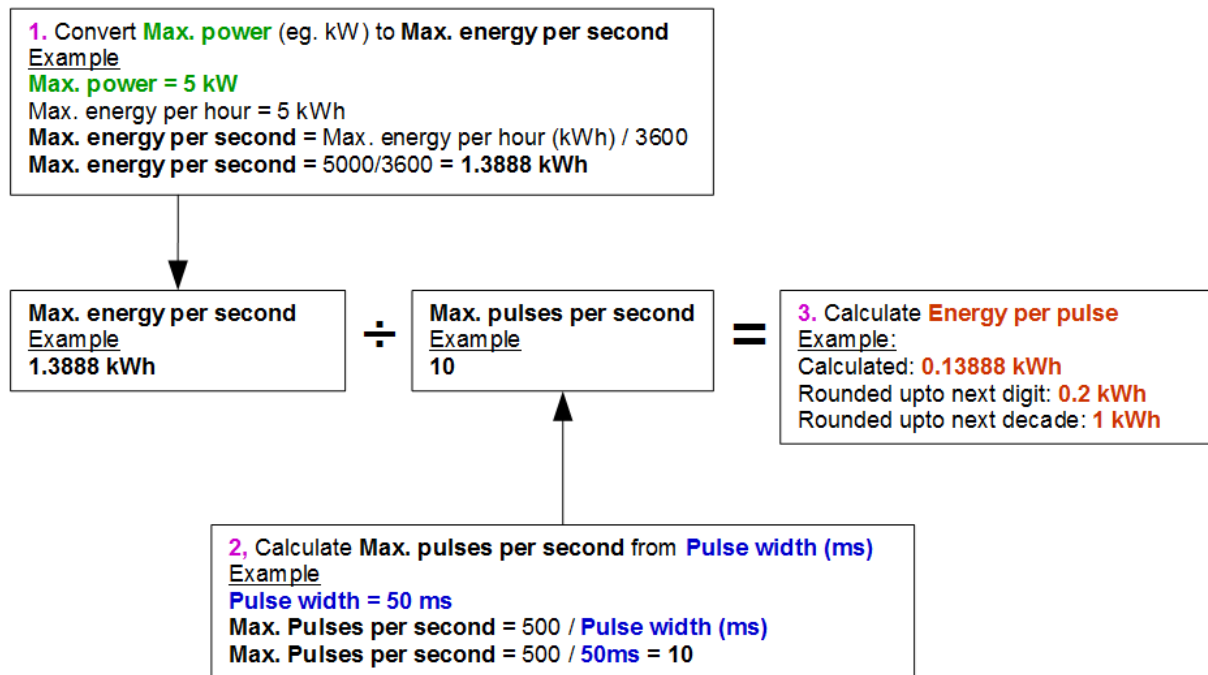

6.2.2 Alarm Output

An Alarm Output generates an alert when a predetermined value is exceeded or receded for Volume, Flow, Energy or Power, or when Signal is lost or gained. When an alarm is activated, a message is generated on the status line and the corresponding output alarm symbol will flash.

1. Select **Output..** from the *Options* menu.
2. Use the UP/DOWN arrow keys to select **Digital Device 1/2/3 Setup**. Press the ENTER key. The *Output 1/2/3* menu is displayed.
3. Use the UP/DOWN arrow keys to select **Function**. Press the ENTER key.
4. Use the UP/DOWN arrow keys to scroll through the output types. Select **Alarm Output**.
5. Use the UP/DOWN arrow keys to select **Measurement Source**.
6. Choose from *Volume, Flow, Energy, Power* or *Signal*.
7. Use the UP/DOWN arrow keys to select **Continue..**
8. According to your choice in step 6, complete the alarm configuration as described in the following sections.

Volume Alarm

9. Use the UP/DOWN arrow keys to select **Direction**. You may select a *Rising* or *Falling* value (as volumes generally only rise until reset, *Rising* is the usual choice).
10. Use the UP/DOWN arrow keys to select **Activation Level**. Set the volume limit for the alarm on this output.
11. If required, set a **Deactivation Level** although this has no effect until the volume totals are reset.
12. Use the UP/DOWN arrow keys to select **Save Setup and Exit..**

Energy Alarm

9. Use the UP/DOWN arrow keys to select **Direction**. Select *Rising*. The device only supports positive energy (an energy loss if operating as a heater, or an energy gain if operating as a chiller).
10. Use the UP/DOWN arrow keys to select **Activation Level**. Set the energy limit for the alarm on this output.
11. If required, set a **Deactivation Level** although this has no effect until the energy total is reset.
12. Use the UP/DOWN arrow keys to select **Save Setup and Exit..**

Flow Alarm

9. Use the UP/DOWN arrow keys to select **Direction**. Select *Rising* to trigger an alarm when a certain flow is exceeded or *Falling* to trigger an alarm when a certain flow is not achieved.
10. Use the UP/DOWN arrow keys to select **Activation Level**. Set the flow limit for the alarm on this output.
11. Set a **Deactivation Level** (the value at which an alarm is cancelled).

- If the direction is set to *Rising*, the alarm is triggered when the flow exceeds the *Activation Level*. The *Deactivation Level* must be a value less than or equal to the *Activation Level*.
- If the direction is set to *Falling*, an alarm is triggered when the flow drops below the *Activation Level*. The *Deactivation Level* must be a value greater than or equal to the *Activation Level*.

12. Use the UP/DOWN arrow keys to select **Save Setup and Exit..**

Example

To generate an alarm when flow exceeds 300 l/min, and reset it when the flow drops below 280 l/min, set **Direction** to *Rising*, **Activation Level** to 300 l/min and **Deactivation Level** to 280 l/min.

About Negative Flows

While operating on negatives flows is possible, it is not recommended because of the potential confusion it can cause. A larger negative flow is actually smaller number. For example, a *Falling* value always refers to a number that is becoming smaller, hence -280 falls to -300.

To generate an alarm when the flow exceeds 300 l/min in the reverse (negative) direction and have it reset only when the volume drops below 280 l/min in the reverse direction then set the **Direction** to *Falling* **Activation Level** to -300 l/min and **Deactivation Level** to -280 l/min. Note the negative signs.

A useful configuration of the alarm mode could be to set two outputs to Alarm Mode using the same Flow Measurement Source. One could be set to be an over-value alarm (no hysteresis) and one an under-value alarm (again, with no hysteresis). If the corresponding outputs are wired in parallel, then the resulting alarm will activate when flow is above a certain threshold OR when it is below a certain threshold.

Power Alarm

1. Use the UP/DOWN arrow keys to select **Direction**. Select *Rising* to trigger an alarm when a certain power is exceeded or *Falling* to trigger an alarm when a certain power is not achieved.
2. Use the UP/DOWN arrow keys to select **Activation Level**. Set the power limit for the alarm on this output.
3. Set a **Deactivation Level** (the value at which an alarm is cancelled).
4. If the direction is set to *Rising*, the alarm is triggered when the power exceeds the *Activation Level*. The *Deactivation Level* must be a value less than or equal to the *Activation Level*.
5. If the direction is set to *Falling*, an alarm is triggered when the power drops below the *Activation Level*. The *Deactivation Level* must be a value greater than or equal to the *Activation Level*.
6. Use the UP/DOWN arrow keys to select **Save Setup and Exit..**

Signal Alarm

The *Signal* alarm ties an output to the loss or reacquisition of a signal. When signal is lost the screen on the flow will read "----" instead of a valid flow number. Signal is deemed to have been lost when the power and SNR ratio is out-of-bounds for longer than the time set in the **Signal Loss**

Time-out field of the *Primary Flow* screen (see page 55). The default value is 3 seconds. When the signal is lost it is deemed to have a value of zero, otherwise it has a value of 1. To generate an alarm when signal is lost set the **Direction** to *Falling* and set the **Activation Level** and **Deactivation Level** to 0.5. These values are set automatically when *Signal* is selected as the *Measurement Source*.

6.2.3 Frequency Output

The output frequency is proportional to the flow rate or power within a specified frequency range of 0 – 200Hz. With the exception of the *Measurement Source* being *Signal*, it only makes sense to measure derivative quantities such as *Power* and *Flow*. In these cases, the instantaneous frequency is directly proportional to the instantaneous flow or power.

Both the lower and upper frequency as well as the values they represent can be set in the **Freq Output** screen. It is usual to set the frequency range to the default of 0 and 200Hz. At 0Hz, the associated output switch is closed continuously. The lowest longest waveform period is 60 second, hence the lowest non-zero frequency that can be generated is $1/60 = 0.01667$ Hz. The precision of the generated frequency averages $\pm 1\%$.

Generally, 0Hz represents zero flow or zero power, so the only selection that needs to be made is the maximum flow or power to be accommodated at 200Hz.

As mentioned in the previous section on **Alarm Mode**, the value of *Signal* can only be zero (no signal) or 1 (signal present). This could be used to generate an audible alarm if the signal is lost. To do this, set the lower frequency to be 100Hz and lower value to be 0 and the upper value to be 1 at a frequency of 0Hz. This will cause the output to be steady when a signal is present and to be 100Hz when signal is lost.

7 NIMH POWER SCREEN

The NiMh power screen is for the monitoring and diagnosis of battery status only, for example, if it is suspected that the battery is not charging correctly. To view the screen:

1. From the *Main* menu, use the Up and Down scroll keys to select **Setup Instrument**. Press the ENTER Key. The *Options* screen is displayed.
2. Use the Up and Down scroll keys to select **Power..** Press the ENTER Key.

7.1 Power Checklist

When viewing the *NiMH Power Board* Screen:

- Check to see if the **Charging Supply** is *On* (the adaptor is connected) and that the **Charger Voltage** is 11VDC or greater. This can also be checked in the status line at the top of the screen by the presence of a plug symbol if an external adaptor is plugged in.
- The battery charger uses a dedicated NiMH charging circuit. If the **Charging** field displays *Yes*, then check the **Battery Current**. It should show a positive value of around 1800mA or greater. If the current switches between zero and some intermediately large value it may indicate that the battery is approaching full charge, or the circuit is trying to ascertain if the battery is nearing end-of-life and needs to be replaced. If the battery is charging, the battery symbol in the status line at the top of the screen will cycle through various levels.
- When charging, the **Battery Voltage** will depend on the charge state. A nearly full battery will be in the region of 7.5 to 8.0VDC.
- **Battery Temperature** should at no time exceed 65 °C or approximately 150 °F.
- If the charger is removed and the device is running on internal power, the battery current will read negative and should be in the region 250 to 300mA depending on whether the backlight is on or off.

Nimh Power Boar		⏏	DD-MM-YY HH:MM:SS
Battery Voltage	6.85	VDC	
Battery Current	-268	mA	
Battery Temperature	29	°C	
PCB Temperature	30	°C	
Charger Voltage	0.0	VDC	
Charging Supply	Off		
Charging	No		
Exit			

If it is suspected that there may be problems with the internal battery contact your distributor.

8 HEAT METER

NOTE: THIS CHAPTER ONLY APPLIES TO PF333 MODELS. PF222 MODELS DO NOT HAVE HEAT METERING CAPABILITIES.

1. From the *Main* menu, use the Up and Down scroll keys to select **Setup Instrument**. Press the ENTER Key. The *Options* screen is displayed.
2. Use the Up and Down scroll keys to select **Heat-Meter..** Press the ENTER Key. The *Rtd-Board* screen is displayed.

Rtd Board	⏏	DD-MM-YY HH:MM:SS
PT100 Sensors		
Hot 46 °C	Energy	5.2107e+01 kJ
Cold 19 °C	Power	2.1784e+01 kW
→Calibrate Temperature Sensors..		
Exit..		

If sensors are connected, **Hot** and **Cold** temperatures will be displayed. A display of “***” indicates no connection or a broken sensor. The screen also displays the current total *Energy* and the last measured instantaneous *Power* level.

8.1 Calibrate Temperature Sensors

Connect the temperature sensors and check that the displayed values are reasonable.

1. Clamp the sensors together and allow the readings to stabilise.
2. The sensors should be reading approximately the same temperature. However, because of small errors in the system, the values from each probe may be fractionally different. If this is the case, the sensors require calibration. To calculate power, it is the difference in temperature that is important, rather than the absolute temperature, although small differences in relative density and specific heat capacity, which are a function of absolute temperature are accounted for in the calculations.
3. Select **Calibrate Temperature Sensors...**
4. Enter the user PIN code (71360). The *Calibrate Sensors* screen is displayed.
5. For **Use for Reference**, select one of the following:
 - *Hot*
Difference in readings between the two sensors is applied as an offset to the Cold sensor.
 - *Cold*
Difference in readings between the two sensors is applied as an offset to the Cold sensor.
 - *Set Value*
If you have an existing temperature measurement system and trust its temperature reading. In this case, the Hot and Cold sensors not only have to be clamped together, but they have to be clamped to the point at which the existing equipment is measuring temperature. Ensure that the temperatures have stabilised.
 - *None*
Remove any offsets. If the temperature difference between the two probes is more than 0.5 °C, a power offset will be seen in subsequent measurements.

6. Select **Calibrate..** The RTD Board screen is displayed. Check that the temperature values now read the same value. A ✓ symbol is shown against the temperature reading that has an offset associated with it and indicates that the probes have already been calibrated.

9 PRIMARY FLOW

The **Primary Flow** screen summarises the flow totals and provides options for their display on the *Flow Reading* screen. To view the *Primary Flow* screen:

1. From the *Main* menu, use the Up and Down scroll keys to select **Setup Instrument**. Press the ENTER Key. The *Options* screen is displayed.
2. Use the Up and Down scroll keys to select **Primary Flow..** Press the ENTER Key. The *Primary Flow* screen is displayed.

The screen displays the forward and reverse flow totals: **Fwd Total** and **Rev Total**. If the totals need to be adjusted, please refer to Section 3.5.2 “Resetting Totals”, on page 29.

To change the display of forward and reverse totals on the *Flow Reading* screen, select **Display Total**. The options are: *Both, None, Fwd Total* and *Rev Total*.

Primary Flow Se 			DD-MM-YY HH:MM:SS
Fwd Total	375.62	1	
Rev Total	0	1	
Display Total	Both		
Damping Mode	Fixed		
Damping	10	sec	
Signal-loss Timeout	3	sec	
Flow Direction	Normal		
Exit			

Damping Time and **Damping Mode** are duplicates of the setting found in the **System** menu (see Section 4.6.5, “Adjusting the Damping Factor” on page 38).

Signal-loss Timeout is discussed on page 50. Once a signal has been acquired, it is deemed to have been lost when the power and SNR ratio are insufficient for longer than the Signal Loss Timeout setting.

Flow Direction allows you to reverse the sensor direction assignments. Changing flow direction may result in a small difference in the magnitude of the reading observed (see section 4.6.2, “Adjusting the Zero-Flow Offset (ZFO)” on page 34).

10 MAINTENANCE AND REPAIR

This instrument does not contain any user-serviceable parts. The following notes are provided as a guide to general equipment care.

IMPORTANT: DO NOT DISASSEMBLE THIS UNIT UNLESS ADVISED BY MICRONICS. RETURN THE UNIT TO AN APPROVED SERVICE AGENT OR PLACE OF PURCHASE FOR FURTHER ADVICE.

1. Ensure the unit is switched off and disconnected from the mains, then wipe the exterior of the instrument with a clean, damp cloth or paper towel. The use of a solvent may damage the surface.
2. The instrument contains a rechargeable battery; dispose safely and in accordance with the local regulations in force in the country of operation.
3. Ensure all cables and connectors are kept clean and free from grease or contaminants. Connectors may be cleaned with a general-purpose cleaner if necessary.
4. Avoid the use of excessive grease/ultrasonic couplant on the sensors as this may impair the performance of the equipment. Excessive grease/couplant can be removed from the sensors and guide rails using an absorbent paper towel and a general-purpose solvent cleaner.
5. We recommend that the ultrasonic couplant is replaced on the sensors every 6 months, especially on pipes where the application is too hot to touch. If the signal level drops below 30% this is also an indication that the sensors need re-greasing.
6. Regularly check all cables/parts for damage. Replacement parts are available from Micronics.
7. Ensure the person who services your instrument is qualified to do so. If in doubt, return the instrument to Micronics with a detailed report on the nature of any problem.
8. Ensure that suitable precautions are taken when using any materials to clean the instrument/sensors.
9. The instrument and sensors should be calibrated at least once every 12 months. Contact Micronics or your local service agent for details.
10. When returning product to Micronics make sure it is clean and please notify Micronics if the instrument has been in contact with any hazardous substances.
11. If the instrument was supplied with dust or dirt caps make sure they are re-fitted when the instrument is not in use.

11 TROUBLESHOOTING

11.1 Overview

If you have a problem with your flow monitoring system, it can be due to any of the following:

Faulty instrument	If you suspect the instrument is faulty you can check it out using a test block as described on page 65. This will establish that the instrument is functional and receiving a healthy signal from the connected transducers.
Incorrect setup	<p>A low, or zero, signal could be caused by incorrect set-up such as:</p> <ul style="list-style-type: none"> • Incorrect site data entered into the instrument. • Incorrect or non-matching ultrasonic transducers selected for use. • Incorrectly fitted transducers – lack of couplant applied, incorrect spacing, insecure attachment. • Poor connections between the probes and the instrument.
Application problem	<p>If you are certain that the instrument is healthy and suitably set-up for the current site; and the probes are properly assembled and fitted correctly, there could be an application problem concerned with the site. Check such conditions such as:</p> <p>Poor pipe outer surface quality</p> <ul style="list-style-type: none"> • Uneven surface preventing good surface contact with the transducer. • Flaking paint (should be removed). • Variable air gap in concrete-covered pipes affecting the ultrasonic signal quality. <p>Poor internal pipe construction</p> <ul style="list-style-type: none"> • Rough internal pipe walls, including excessive rust, affecting fluid flow (see roughness factor). • Internal welds positioned in the transducer signal path affecting the signal quality. • The 'drippings' in galvanised-dipped pipes or other irregularities interfering with the signal path. <p>Incorrect probe location</p> <ul style="list-style-type: none"> • Transducers located too close to bends or valves, disturbing the flow profile. • Transducers located too close to insertion probes, disturbing the flow profile. • For horizontal pipework transducers should not be positioned on the top of the pipe. <p>Poor fluid conditions within the pipe</p> <ul style="list-style-type: none"> • Fluid contains bubbles, high particle density or sludge. • Air in the top of the pipe. <p>Low fluid flow within the pipe</p> <ul style="list-style-type: none"> • Pipe obstructions. • Malfunctioning valve not opening fully (or closed inadvertently). <p>Liquid content problems</p> <ul style="list-style-type: none"> • Multiple liquid contents do not comply accurately to expected sound speed criteria. • Very hot pipe almost turns water to steam and therefore exhibits the wrong speed characteristics – could be due to reduced pipe pressure. • Flashover – liquid turns into a gas because of lower than required pressure. <p>Automatic signal loss recovery</p> <ul style="list-style-type: none"> • If the signal is lost or the Quality falls below 40% then the set-up procedure, normally invoked by Read Flow in the main menu, is automatically run until a good quality signal is found.

11.2 General Troubleshooting Procedure

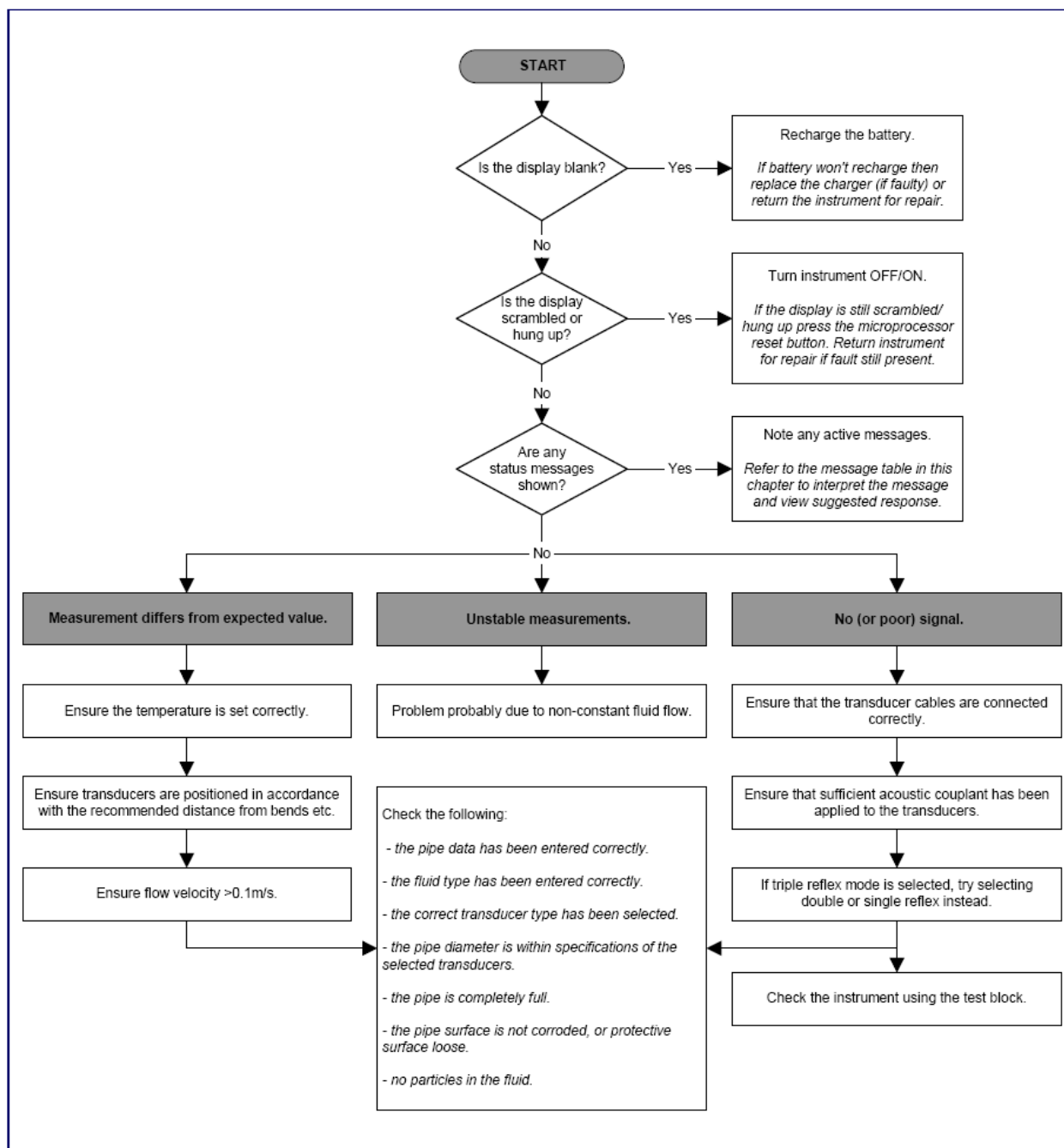

Figure 16 Troubleshooting chart

11.3 Warning and Status Messages

Warnings, errors and status messages appear on the second top line of the display. When there is more than one message to be displayed then the display will cycle between them, unless an error is URGENT. Urgent may need user intervention and can only be cleared by pressing 'delete' or the cause of the error being remedied. URGENT errors are marked as such in the interpretation.

Status messages may be hidden until normal and urgent errors are redressed. Normal errors, such as "*Code is invalid*", are automatically removed after a period of time. All errors can be removed by pressing 'delete' but with most serious and urgent errors, they may be generated again after a minute or so.

Please check the Response associated with the given error and perform any required actions before contacting your distributor.

11.3.1 Flow Rate Errors & Messages

NO SIGNAL	<p>Interpretation: URGENT: The transducers cannot send or receive signals.</p> <p>Response: Check that all cables are connected, transducers are on the pipe correctly with sufficient couplant on the faces.</p> <p>This condition could also be due to a partially empty pipe, aerated liquid, particulate content too high or when the condition of the pipe being measured is poor.</p> <p>If the cause is remedied, then the error will be automatically removed, otherwise press 'delete'.</p>
Flow Computation Fault	<p>Interpretation: URGENT: An internal error occurred when computing flow.</p> <p>Response: Restart the Portaflow. If the problem persists, contact the distributor. Press 'delete' to remove this error.</p>
Velocity Out of Range	<p>Interpretation: URGENT: The instantaneous flow velocity has, at least temporarily, exceeded a specified maximum.</p> <p>Response: This is an unusual condition. It is not fatal and may occur sporadically. If it persists, check your installation. Press 'delete' to remove this error.</p>
Separation distance impossible	<p>Interpretation: The calculated sensor separation was less than zero.</p> <p>Response: Check all the site parameters and the sensor chosen.</p>

11.3.2 Heat Meter Errors & Messages

RTD Cold Sensor fault	<p>Interpretation: URGENT: The cold sensor probe is either not connected or is faulty.</p> <p>Response: Check the probe is connected. If you are running a unit containing a heat-meter and the probe is not connected, you may simply delete the error and continue. This error may be observed at start-up with no RTD probes connected. In this case the error will be automatically deleted after 30 seconds.</p>
RTD Hot Sensor fault	<p>Interpretation: URGENT: The hot sensor probe is either not connected or is faulty.</p> <p>Response: Check the probe is connected. If you are running a unit containing a heat-meter and the probe is not connected, you may simply delete the error and continue. This error may be observed at start-up with no RTD probes connected. In this case the error will be automatically deleted after 30 seconds.</p>

11.3.3 Current Loop and Digital Output Errors & Messages

[measurement source] not compatible with [function]	<p>Interpretation: The [measurement source] chosen is not compatible with the desired output [function].</p> <p>Response: Choose another (compatible) measurement source and / or function. See Section 6.2, “Digital Outputs” on page 45.</p>
[internal] board failed to report.	<p>Interpretation: The [internal] board failed to respond to a discovery message and has been taken offline momentarily.</p> <p>Response: This error may be the result of a temporary computational overload. Go to the Options screen and check the board status. Try first to restart and if the error still persists, reset the Portaflow.</p> <p>If after reset, all boards do not report as “OK”, note the failing board and call your distributor.</p>
Current loop open or short	<p>Interpretation: The current loop is either open circuit (not connected) or possibly a short circuit resulting in internal components overheating.</p> <p>Response: Either turn the current loop off if it not required, or connect it as needed. Ensure a suitable load is being placed on the current loop and it is not driving into a direct short circuit. The alarm can be cleared by pressing delete, but if the condition is not rectified, it will return in approximately one minute.</p>

Current loop alarm activated	<p>Interpretation: This message is for information only. It is generated when alarm conditions have been met for the current loop. See Section 6.2.2 “Alarm Output” on page 49.</p> <p>Response: Clear the alarm by deleting it and attend to the fault. Deleting the alarm does not stop the error current being generated as long as the fault remains.</p>
Alarm on output [n] activated	<p>Interpretation: This message is informative only. It is generated when alarm conditions have been met for digital output [n]. See Section 6.2.2 “Alarm Output” on page 49.</p> <p>Response: Clear the alarm by deleting it and attend to the fault. Deleting the alarm does not stop the output generating the alarm as long as the fault remains.</p>
Error current out-of-bounds	<p>Interpretation: An attempt was made to define the error current within the normal working range of the current loop. For example, this error would be generated if the working range were 0 to 16mA and the error current was set to any value below 16mA. The Portaflow will try to redefine a valid error current.</p> <p>Response: Redefine the error current or change the working range if the calculated value is not desirable.</p>
Error current invalid. Source disabled	<p>Interpretation: The entire range of the current loop (0 to 24mA) has been defined as valid, so an error current is not possible. In this case the alarm function is disabled.</p> <p>Response: If an error current is required, redefine the working region to be a smaller range.</p>

11.3.4 Data Logging Errors & Messages

USB drive not inserted	<p>Interpretation: A USB drive must be inserted into the external port before the desired operation can proceed.</p> <p>Response: Insert a USB drive into the external port.</p>
Could not copy CSV file	<p>Interpretation: An error occurred copying the CSV from the internal storage to the external flash drive.</p> <p>Response: Try the operation again. If this fails, turn the Portaflow off and then on again. Select the site whose log you wish to obtain and attempt to copy the file again.</p>
Could not delete index file.	<p>Interpretation: This file is an internal file which is associated with the CSV file for each site. The file could not be deleted.</p> <p>Response: Try the operation again. If this fails, turn the Portaflow off and then on again. Select the site whose log you wish to remove and attempt to clear the log again.</p>

Could not delete CSV file.	<p>Interpretation: The internal CSV file associated with the site could not be deleted.</p> <p>Response: Try the operation again. If this fails, turn the Portaflow off and then on again. Select the site whose log you wish to remove and attempt to clear the log again.</p>
Badly formatted date or time	<p>Interpretation: The format of the date and time field is invalid.</p> <p>Response: Re-enter the time and date in the correct format.</p>
Date or time is out of bounds	<p>Interpretation: The scheduled date and time entered is more than a year in advance.</p> <p>Response: Re-enter a time and date that is not so far into the future.</p>
Start time too close	<p>Interpretation: The scheduled logging start time must be at least two minutes into the future.</p> <p>Response: Re-enter a start time more than two minutes in advance of current time.</p>
Logging period too short	<p>Interpretation: The minimum logging period for a scheduled start is 60 seconds.</p> <p>Response: Entered a logging stop time that is more than 60 seconds beyond the logging start time.</p>
Start or stop time invalid	<p>Interpretation: The date entered is not valid. For example: 31 June or 30 February, or 25:00:00</p> <p>Response: Enter a valid date and time.</p>
Operation timed-out	<p>Interpretation: An internal error occurred, and the operation timed out.</p> <p>Response: Try the operation again and if the result is the same, try switching the Portaflow off and then on again. Retry the operation and if it is still failing then contact your distributor or return the item for repair.</p>
Log drive full	<p>Interpretation: URGENT: The internal storage is full.</p> <p>Response: Delete some logs. See Section 5.5 “Clearing Log Files” on page 41. Press ‘delete’ to remove this error.</p>
Stopping Logging	<p>Interpretation: URGENT: The internal storage is full so logging will be stopped.</p> <p>Response: Delete some logs. See “Clearing Log Files” on page 41. Press ‘delete’ to remove this error.</p>

11.3.5 Battery Errors & Messages

Battery critically low!	<p>Interpretation: URGENT: The internal battery voltage is less than 6.1 volts.</p> <p>Response: Connect the external charger. Press 'delete' to remove this error.</p>
BATTERY EXHAUSTED! Shut down in [n] sec!	<p>Interpretation: The internal battery voltage is less than 5.25 volts. The Portaflow will perform a controlled shutdown in 15 seconds if an external charger is not connected. The time to shutdown is [n] seconds.</p> <p>Response: Connect the external charger. Press 'delete' to remove this error.</p>

11.3.6 Set-up and Other Errors & Messages

Too many errors	<p>Interpretation: The Portaflow generated too many errors as a result of a fault and some errors may not have been reported.</p> <p>Response: Respond to the errors highlighted.</p>
Too many urgent errors	<p>Interpretation: The Portaflow has generated too many urgent errors as a result of a fault and some errors may not have been reported.</p> <p>Response: Delete urgent errors before continuing. Urgent errors are displayed before normal errors, so they are cleared first by pressing the 'delete' key.</p>
Poorly formatted error message	<p>Interpretation: Internal, NON- FATAL System error.</p> <p>Response: Delete the error. Take note of the current situation that lead to this error and report it when convenient.</p>
Site DB is full	<p>Interpretation: The number of sites has exceeded the maximum of 12.</p> <p>Response: Delete a site as directed in Chapter 4, "Managing Named Sites" on page 30.</p>
Site name illegal or duplicate	<p>Interpretation: Site names must be unique and contain eight or fewer characters comprising letters, numbers dashes or underscores.</p> <p>Response: Enter a site name that complies with the interpretation above. Note that names are case insensitive, for example, site ELY is a duplicate of site Ely.</p>
Energy calculations unreliable	<p>Interpretation: The temperature used in heat-meters calculations is outside that which can be accurately calculated.</p> <p>Response: This is a NON-FATAL error. If the error is persistent, check your installation for temperatures that are out-of-bounds, and check the leads to the temperature probes.</p>

RTD Board fault Power Board fault Logger Board fault Output Board fault Flow Board fault	<p>Interpretation: URGENT: The respective board has not reported to the central controller in the last minute.</p> <p>Response: Try restarting the Portaflow. If the board is still reported as missing or faulty, call your distributor or return your device for repair. You may press 'delete' to remove this error but some or all functionality may be lost if this error is persistent and you continue operate the device.</p>
Limits are xx.x [text] to yy.y [text]	<p>Interpretation: The values entered were out of bounds for this setting. The smallest value allowed is xx.x and the largest is yy.y. Optional units [text] may accompany this message. If not, then it is implied that the units are those currently set.</p> <p>Response: Enter a value within the specified limits. Note that the limits quoted may be dependent on other parameters already set.</p>
Site DB failure. Restoring default values.	<p>Interpretation: When reading parameters from the database, some site parameters appeared corrupted, so all parameters have been restored to initial values.</p> <p>Response: Re-enter parameters for this site. Press 'delete' to remove this error.</p>
Code is invalid	<p>Interpretation: Either the user or factory pin code is incorrect.</p> <p>Response: Try again.</p>
Unknown product	<p>Interpretation: The board count for product does not match the product type specified.</p> <p>Response: This is a serious error. Restart the Portaflow. If the problem persists, contact your distributor for further advice.</p>
Illegal to edit or delete this information	<p>Interpretation: This field cannot be modified or deleted. This usually occurs when trying to edit or delete the Quickstart site.</p> <p>Response: None required.</p>
ERR: unknown board type	<p>Interpretation: Portaflow internal error. The controller has attempted to request a board that does not exist.</p> <p>Response: Reset the Portaflow to be safe. Record the conditions under which the error occurred and report them to the distributor when convenient.</p>
Value out of bounds	<p>Interpretation: The values entered were out of bounds for this variable. This error is similar to the error "Limits are xx.x [text] to yy.y [text]".</p> <p>Response: Enter a valid value.</p>
System Error [nnnn]	<p>Interpretation: A serious internal error occurred. This indicates an error condition that should not be possible. It may or may not be fatal.</p> <p>Response: Record the error number and conditions that lead to the error. Ideally turn the Portaflow off then on. When convenient report the error number and conditions to your distributor.</p>

11.4 Test Block

A test block is included with the Portaflow equipment to allow the transducers and inter-connecting cables to be functionally checked.

1. Switch ON the instrument.
2. Select **Quick Start** and enter the parameters shown in the table below for the appropriate transducer type (A or B):

Parameter	A Sensors	B Sensors
Pipe outside diameter	30.0mm	50.0mm
Pipe wall thickness	14.0mm	22.0mm
Pipe lining thickness	0.00mm	
Pipe wall material	Plastic	
Fluid type	Water	
Mode	Diagonal	
Temp	20°C	

3. At the end of the *Quick Start* procedure (see page 25), the *Summary* screen is displayed. Press the UP or DOWN arrow button. The *Sensors* screen is displayed.
4. Use the UP/DOWN scroll keys to select **Sensor Set**. Press the ENTER key.
5. Select the appropriate sensor (the default will be "A") and press the ENTER key.
6. Select **Sensor mode**, choose **Diagonal** and press the ENTER key.
7. Select **Return to Summary screen** and press the ENTER key.
8. Check that the 3 parameters displayed are correct.
9. Apply acoustic couplant to the sensors and attach them to the test block with the connectors positioned towards the centre of the test block as shown in Figure 17, and temporarily secure them in place using elastic bands or tape.
10. Connect the sensors to the Portaflow using the cables provided (see page 5).
11. Press the ENTER key to display the *Flow Reading* screen.
12. Press the SYSTEM key (2) to display the *System Settings* screen.

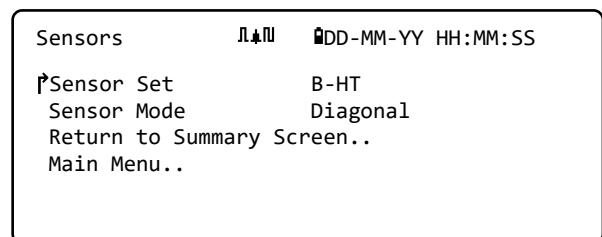
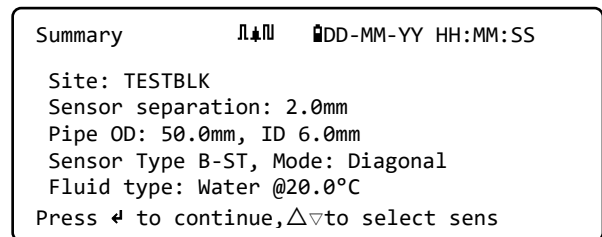

13. Set **Damping** to at least 10 seconds.
14. Select **Save Setup & Exit** and press the ENTER key to return to the *Read Flow* screen.
15. The flow reading value displayed is not important. Ignore messages like “Flow Velocity Out Of Range” if they occur. The fact that a reading is obtained indicates that the instrument is functioning. The value may fluctuate but this is normal.
16. The signal strength indicator at the left of the display should show 3–4 bars. As a double check, press the DIAGS button and scroll down to the Signal reading. For an A-sensor the value should be around 50dB or lower. For a B-sensor the signal level should be around 45dB or lower. In either case the average SNR value should be around 55dB or lower.

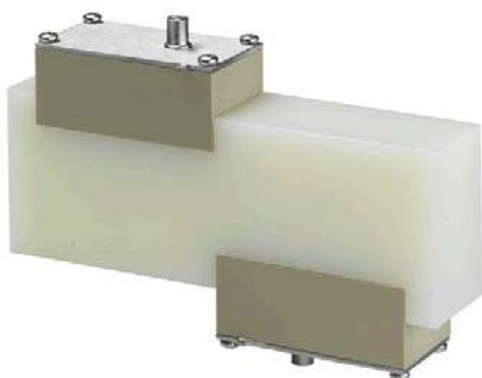

Figure 17 Sensors on the test block

11.5 Reset

To reset the Portaflow, carefully insert a straightened paperclip into the pinhole located in the right-hand side of the instrument to operate the internal reset switch. Hold the paperclip perpendicular to the instrument while doing this.

Note: If the instrument is reset while logging, it is likely that at least some log data will be lost. In addition to this it may also be possible that some user settings may be corrupted. These settings will be reset to default value when the unit is repowered.

11.6 Diagnostics

This feature is designed for advanced users and is intended to provide information that will aid the user to diagnose problems – e.g. no signal strength.

When operating in the FLOW or ENERGY (PF333 Only) READING modes you can access a diagnostics screen by pressing the **Diags** function key. This will display the operating values for the following parameters.

ETA (µs)	Value the instrument predicts will be the time in µsecs that it should take for the acoustic wave to propagate across a particular pipe size. This value is ascertained from the data entered by the user: pipe size, material, sensor set etc.
ATA (µs)	Value the instrument measures as the time taken for the acoustic wave to propagate across the pipe. It is used to see if the signal is being taken from the burst, at the correct time to get the strongest signal. This value is normally a few µs below the calculated µs value. If, however, this value is much greater than the calculated time then there is a problem with the set-up.
Upstream Fluid Time	The time the upstream wave spends in the fluid in µsecs.
Delta T (ΔT in ns)	The difference between the upstream and downstream time in nano-seconds.
Instantaneous Velocity (m/sec)	Instantaneous fluid velocity.
Cut-off Velocity (m/sec)	The current cut-off velocity (see page 34)
Flow (m/s)	Instantaneous volumetric flow in m ³ /s to 3 decimal places.
SNR (dB)	Signal to Noise ratio in decibels (dB). A strong signal will generally exhibit an SNR of greater than 45 dB. A good signal will generally exhibit an SNR of greater than 40 dB. SNR is literally the difference between the Signal level and the Noise level in dB.
Signal (dBV)	The unreferenced signal level (in dBV) of the received signal.
Noise (dBV)	The unreferenced background noise level (in dBV) of the received signal.
Gain (dBV)	The gain value (in dBV) represents the amount of amplification that the received signal has undergone before signal analysis is undertaken. A large gain figure can indicate that the ultrasonic signal is being strongly attenuated by something in its path. This could be because of the lack of couplant, poor sensor alignment or other factors.
Pipe Bore (mm)	The pipe bore (always in mm) – see pages 25 and 30
Advanced Diagnostics..	Display the Advanced Diagnostics (see below)

11.6.1 Advanced Diagnostics

LFF (ns/m/s)	Linear Flow Factor in nano seconds per metre per second.
Average Velocity (m/sec)	A rolling average raw velocity over the last 25 seconds
Average delta t (ns)	A rolling average ΔT over the last 25 seconds
Reynolds Number	The calculated Reynolds number
Roughness factor (mm)	The current roughness factor (always in mm) – see page 37
Zero Flow Offset (m/sec)	The currently set zero flow offset velocity being used – see page 34
Calibration factor	The currently set user calibration – see page 35
Separation distance (mm)	The computed separation distance (always in mm) as seen on the Summary screen before flow reading began.
Solid time (μs)	The amount of time that the ultrasonic wave spends in solid materials.
Flow Side Temperature ($^{\circ}$C)	The flow side temperature (if a Heatmeter board is fitted)
Return Side Temperature ($^{\circ}$C)	The return side temperature (if a Heatmeter board is fitted)
Sensor Set	The type of sensor – see page 27
Sensor Mode	The current operating mode – see pages 2, 25 and 33
Correction Factor	The current correction factor

12 APPENDIX

12.1 Specification

General	
Flow Measurement Technique	Transit time
Flow Velocity Range	Minimum Velocity 0.1m/s; Max Velocity 10m/s: Bi-directional.
Turn Down Ratio	100:1
Accuracy	Accuracy Pipe ID > 75mm – $\pm 0.5\%$ to $\pm 2\%$ of flow reading for flow rate >0.2m/s Accuracy Pipe ID 13-75mm – $\pm 2\%$ of flow reading for flow rate >0.2m/s
Repeatability	$\pm 1.5\%$ of measured value or $\pm 0.02\text{m/s}$ whichever is the greater.
Reynolds Number Correction	Flow velocity corrected for Reynolds number over entire velocity range.
Measurement Period	1 second
Selectable Flow Units	VELOCITY: m/sec, km/hr, ft/sec, yd/sec, mi/hr. FLOW RATE: l/s, l/min, l/h, m ³ /s, m ³ /min, m ³ /h, Ml/s (million litres/s), Ml/min (million litres/min), Ml/hr (million litres/hour), Ml/day (million litres/day), USgals/sec, USgals/min, USgals/h, USgals/day, Barrel/h, Barrel/day, ft ³ /sec, ft ³ /min, ft ³ /hr, MUSgal/hr (million US gallons/hr), MUSgal/day (million US gallons/day), Imp Gals/sec, Imp. Gal/m, Imp Gals/hr, Imp Gals/day, Barrels/hr, Barrels/day..
Selectable Volume Units	l, m ³ , Megalitre, Imperial gallons, US gallons, Oil Barrel (42 US gallons), ft ³ , Mega-US gallons.
Total Volume	12 digits – forward and reverse
Applicable Fluid Types	
Fluid Condition	Clean liquids that have less than 3% by volume of particulate content. Applications include river water, sea water, potable water, demineralised water, glycol/water mix, hydraulic systems and diesel oil.
Applicable Pipe Types	
Pipe Materials	Any sonic conducting medium such as Stainless Steel, Copper, UPVC, PVDF, Galvanised Steel, Mild Steel, Glass, Brass. Including pipes lined with Epoxy, Rubber, Steel, Plastic.
Pipe Dimension (OD)	Min 13 mm; Max 2000 mm
Pipe Wall Thickness	1 mm – 75 mm (dependent on material)
Pipe Lining	Applicable pipe linings include Rubber, Glass, Epoxy, Steel, Plastic, Concrete.
Pipe Lining Thickness	0 mm – 25 mm
Pipe Wall Temperature Range	Standard sensor operating temperature is -20°C to +135°C.
Transducer Sets	
Temperature Range (Standard)	-20°C to +135°C.
Temperature Sensors	
Type	PT100 Class B 4 wire
Range	2 to 180 °C (36 to 356 °F)
Resolution	0.1 °C (0.2 °F)
Minimum Delta T	0.3 °C (0.5 °F)

Datalogger (333 models only)	
Data Logged	Log application details, time, date, flow rate, forward total, reverse total, flow velocity, ⁵ flow side temperature, ⁵ return side temperature, ⁵ temperature difference, ⁵ power, ⁵ total energy, signal Quality, signal SNR, signal status. Log data units are those selected when starting to log flow.
Data size	8GB (>100,000,000 records)
Time Stamping	All data points
No. Sites	12
No. Datapoints per Site	All free memory can be allocated to any site.
Programmable Logging Interval	5 secs to 28 days. Stop logging only when memory is full. Logged data copied to PC via USB BOM drive. CSV file can be imported to Microsoft™ Excel™ or other spreadsheet software.
Energy meter (333 models only)	
Selectable energy units	W, kW, MW, GW, BTU/sec, BTU/hr, kCal/sec, kCal/hr
Energy total units	J, kJ, kW/hr, MJ, GJ, BTU, kCal
Languages	
Standard supported languages	English, French, German, Spanish.
Outputs	
USB Interface	Supports most USB 2.0 BOM drives.
Analog Output	User selectable in the range 0 to 24 mA. <i>Accuracy:</i> < 0.3% of full scale with user compensation. <i>Alarm current:</i> Any outside working range between 0–24mA. <i>Isolation:</i> 100V AC/DC. <i>Maximum Load:</i> 600Ω @ 20mA.
Switched Output	Opto-isolated MOSFET relay. Max load voltage/current: 24V DC or 24V AC / 500mA <i>Isolation:</i> 1MΩ @ 100V AC/DC. Pulse mode <i>Pulse repetition rates:</i> up to 50 pulses/sec (depending on pulse width). Frequency mode <i>Max. pulse frequency:</i> 200Hz <i>Flow at max frequency:</i> User selectable
Electrical	
Power Supply	
Input Voltage	Nominal 12VDC
Power Consumption	< 3.2W with backlight on and current loop output @24mA, all outputs activated. < 20W (when charging),
Battery	
Technology	5-cell NiMH
Capacity	4.0Ah

⁵ On models with a heat-meter.

Operating Time	Typically > 14 hours reading flow with backlight off, current loop off and alarms inactive >9 hours continuous with backlight on and current loop output @24mA, all outputs activated.
Recharge Time	Typically < 2.5 hours
Service Life	>500 charge/discharge cycles
Mechanical	
Carry case	
Rating	All components are contained in a hard-wearing carrying case with a protective moulded foam insert. (PF333 is supplied with an IP67 rated carrying case)
Enclosure	
Material	Flame retardant injection moulded ABS.
Dimensions	264mm x 168mm x 50mm.
Weight (including Battery)	1.1 kg
Protection	IP54
Keypad	
Number of Keys	16
Display	
Format	240 x 64 pixel graphic display, high contrast black-on-white, with backlight.
Viewing Angle	Min 30°, typically 40°
Environmental	
Operating Temperature	-20°C to +50°C
Storage Temperature	-25°C to +65°C
Operating Humidity	90% RH MAX at +50°C
Charging Temperature	0°C to +40°C
Approvals	
Safety	BS EN 61010
EMC	BS EN 61326 - 1:2006, BS EN 61326-2-3:2006
Shipping Information	
Box Dimensions	(PF333) 410mm x 205mm x 355mm (PF222) 510mm x 140mm x 440mm
Weight	(PF333) 7.5 kg (PF222) 6.0 kg
Volumetric Weight	(PF333) 5.7 kg (PF222) 6.3 kg
Micronics reserve the right to alter any specification without notification.	

12.2 Declaration of Conformity



EU Declaration of Conformity

Micronics Ltd

Knaves Beech Business Centre
Davies Way, Loudwater,
High Wycombe, Bucks.
HP10 9QR

The Products Covered by this Declaration: Portaflow 333, 222, 440IP

This product is manufactured in accordance with the following Directives and Standards:

Directive 2014/30/EU of the European Parliament and of the Council of 26 February 2014 on the approximation of the laws of the Member States relating to electromagnetic compatibility.

Directive 2014/35/EU of the European Parliament and of the Council of 26 February 2014 on the harmonisation of the laws of Member States relating to electrical equipment designed for use within certain voltage limits.

The Basis on which Conformity is being Declared

The Manufacturer hereby declares under his sole responsibility that the products identified above comply with the protection requirements of the EMC directive and with the principle elements of the safety objectives of the Low Voltage Equipment directive, and that the following standards have been applied:

BS EN61010-1:2010 Safety requirement for electrical equipment for measurement control and laboratory use. Part 1: General requirements.

BS EN61326-1:2013 Electrical equipment for measurement control and laboratory use EMC requirements. Part 1: General requirements.

BS EN61326-2-3:2013 Electrical equipment for measurement control and laboratory use EMC requirements. Part 2-3: Particular requirements – Test configuration and performance criteria for transducers and integrated or remote signal conditioning.

This declaration of conformity is issued under the sole responsibility of the manufacturer.

Signed for and on behalf of : Micronics Ltd.

Signature:

Printed Name: Michael Farnon

Title: Managing Director

Date: January 2021

Location: Loudwater

Attention!

The attention of the specifier, purchaser, installer, or user is drawn to special measures and limitations to use which must be observed when these products are taken into service to maintain compliance with the above directives.

Details of these special measures and limitations to use are available on request, and also contained in the product manuals.

Registered Office: Micronics Limited, Knaves Beech Business Centre, Davies Way, Loudwater, Buckinghamshire. HP10 9QR.

Web site: www.micronicsflowmeters.com Tel: +44 (1628) 810456

Directors: E J Farnon, E Farnon, M A Farnon, D B Leigh

Registration No 1289680

VAT Registration No 303 6190 91

