

Installation & Maintenance Instructions

U1000MKII

U1000MKII-FM: Clamp-on Ultrasonic Flow Meter

U1000MKII-HM: Clamp-on Ultrasonic Heat Meter



Supplied by

247able.com

Call us on +44 (0)118 916 9420 | Email info@247able.com

U1000MKII

U1000MKII-FM: Clamp-on Ultrasonic Flow Meter

U1000MKII-HM: Clamp-on Ultrasonic Heat Meter

User Manual



U1000MKII-HM shown

Micronics Ltd, Knaves Beech Business Centre,
Davies Way, Loudwater, High Wycombe, Bucks HP10 9QR

Telephone: +44(0)1628 810456 **E-mail:** sales@micronicsltd.co.uk

www.micronicsflowmeters.com

CONTENTS

1	INTRODUCTION	1
1.1	General Description	1
1.2	How Does It Work?	2
1.3	Package Contents	3
1.4	Display.....	4
1.5	Quick Start Procedure	5
2	INSTALLATION	6
2.1	Identify Suitable Location	6
2.1.1	Additional Considerations for Locating U1000MkII-HM	6
2.1.2	Clean the Pipe's Flow Sensor Contact Area	7
2.2	Connect Power and Signal Cables	7
2.2.1	Power Supply	7
2.2.2	Pulse Output Connection	7
2.2.3	Current Output (U1000MkII-FM only).....	8
2.2.4	Modbus Connections (if fitted)	8
2.2.5	M-Bus Connections (if fitted).....	10
2.2.6	Temperature Sensor Probes (U1000-HM only).....	12
2.3	Switch On	14
2.3.1	U1000MkII-FM.....	14
2.3.2	U1000MkII-HM	15
2.4	Adjust Flow Sensor Separation.....	16
2.5	Apply Gel Pads.....	16
2.6	Clamp Sensor Assembly to Pipe.....	16
2.6.1	Pipe Adaptors.....	17
2.6.2	Attaching to Pipe	17
2.7	Remove Sensor-Holding Screws	18
2.8	Connect Electronics Module	19
2.9	Attach the Temperature Sensors (U1000MkII-HM Only).....	19
2.10	Normal Operation	21
2.10.1	U1000MkII-FM.....	21
2.10.2	U1000MkII-HM	21
2.10.3	Troubleshooting the Flow Reading	22
2.11	Clip Electronics Module to Sensor Assembly	22
3	MENUS	23
3.1	Accessing the Menus.....	23
3.2	Setup Menu	24
3.3	Modbus Menu.....	25
3.4	M-Bus Menu	25

3.5	Current Output Menu (U1000MkII-FM only)	26
3.6	Pulse Output Menu	27
3.7	Calibration Menu	28
3.8	Volume Totals Menu	28
3.9	Diagnostics Menu	29
4	OUTPUTS	30
4.1	Pulse Output	30
4.1.1	Volumetric Pulse	30
4.1.2	Frequency Mode	30
4.1.3	Energy Pulse (U1000MkII-HM only)	31
4.1.4	Flow Alarm - Low Flow	31
4.1.5	Flow Alarm – Signal Loss	31
4.2	4-20mA Current Output (U1000MkII-FM only, if fitted)	31
4.3	Modbus (if fitted)	32
4.4	M-Bus (if fitted)	35
4.4.1	Acknowledge Function	35
4.4.2	Select Slave Function	36
4.4.3	Data Transfer Functions	36
4.4.4	REQ_UD2 – REQUEST DATA	37
4.4.5	RSP_UD2 – RETURN DATA	38
4.4.6	Switch Baud Rate Function	39
4.4.7	Change Primary Address Function	42
5	RELOCATING THE UNIT	43
6	APPENDIX	44
6.1	Specification	44
6.2	Default values	46
6.3	Limitations with Water-Glycol Mixtures	46
6.4	Positioning	46
6.5	Error and Warning Messages	48
6.5.1	Error Messages	48
6.5.2	Example Error Messages	48
6.5.3	Modbus Error Messages (if Modbus fitted)	49
6.5.4	Flow Errors	49
6.5.5	Flow Warnings	49
6.5.6	Data Entry Errors	50
7	DECLARATION OF CONFORMITY	51

1 INTRODUCTION

1.1 General Description

This manual describes the installation and use of the two models in the U1000MkII range:

- **U1000MkII-FM** is an ultrasonic clamp-on flow meter for measuring flow rate and total flow with a volume pulse output and optional Modbus, M-Bus or 4-20mA flow proportional output. It can be used as a standalone meter or as part of an integral management system.
- **U1000MkII-HM** is an ultrasonic clamp-on thermal, heat/energy meter. It uses ultrasound to measure flow rate and is also equipped with PT100 temperature sensors to measure flow and return temperatures. The U1000MKII-HM displays energy rate and totalised energy with pulse output and communication options, so it can be used as a standalone meter or as an integral part of Automatic Monitoring & Targeting (aM&T) or a Building Energy Management System (BEMS).

The electronics and sensor housings form an integral unit which attaches to the pipe using the supplied hose clips. Power to the unit is provided by an external 12 - 24V DC/24V AC power supply (7W/7VA minimum). The unit operates on steel, stainless steel, copper and plastic pipes with internal diameter in the range 20mm (0.8”) to 165mm (6.5”) depending on the product purchased. The models can also be supplied with Modbus or M-Bus digital communication options.

Typical applications:

U1000MkII-FM

Hot water metering and flow measurement
 Flow measurement for heat metering
 Chilled water metering and flow measurement
 Potable water metering and flow measurement
 Process water metering and flow measurement
 Ultra-pure water metering and flow measurement.

U1000MkII-HM

Hot water metering and flow measurement
 Flow measurement for Energy Metering
 Chilled water metering and flow measurement

NOTE:

U1000MkII-HM units' default configuration are:

- **Instrument Type:** Heating
- **Installation Side:** Return
- **Fluid:** Water

Return refers to the location of the flow measurement relative to flow circuit.

1.2 How Does It Work?

The U1000MKII uses a cross correlation transit time algorithm to provide accurate flow measurements.

An ultrasonic beam of a given frequency is generated by applying a repetitive voltage pulse to the transducer crystals. This transmission goes first from the downstream transducer to the upstream transducer as shown in the upper half of Figure 1. The transmission is then made in the reverse direction, being sent from the upstream transducer to the downstream transducer as shown in the lower half of Figure 1. The speed at which the ultrasound is transmitted through the liquid is accelerated slightly by the velocity of the liquid through the pipe. The subsequent time difference $T1 - T2$ is directly proportional to the liquid flow velocity.

With HM models, two temperature sensors measure the difference in temperature between the flow and return of the flow system being monitored. The temperature difference, in combination with the volume of water that has flowed through the system, is then used to calculate the energy transferred to or from the water.

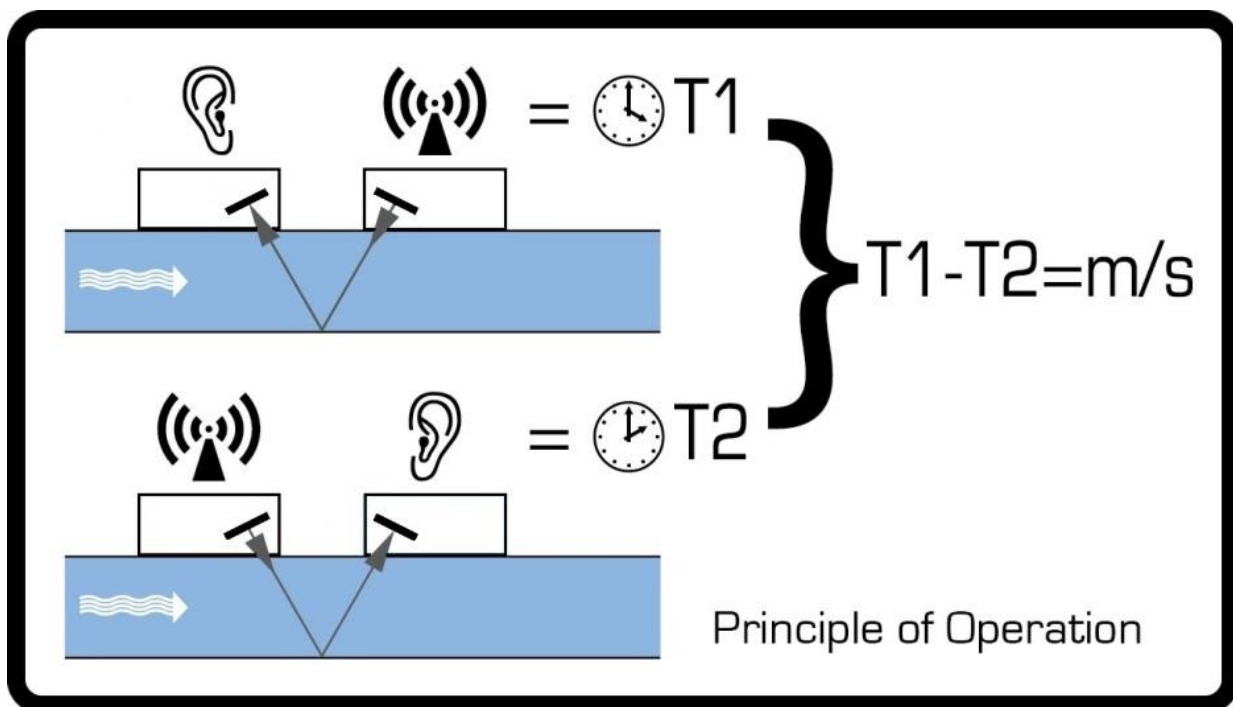

Figure 1 Principle of Transit-Time operation

1.3 Package Contents

The unit consists of two parts:

1. **Sensor Assembly**
Incorporating guide rails and two transducers for flow measurement.
2. **Electronics Module**
Consisting of the keypad and display, power, signal and comms connections. The Electronics Module clips onto the Sensor Assembly.

In addition, the kit contains:

3. Adhesive gel pads (4) p/n 223-5003.
4. 2-part adaptors for fixing sensor assembly to pipes with an OD less than 60mm (2)
p/n 225-5005 (U1000 SMALL PIPE V CLAMP)
p/n 225-5009 (U1000 VERY SMALL CIRCLE PIPE CLAMP)
5. *U1000MkII-HM only*: Non-releasable stainless cable ties for temperature sensors (2)
p/n 223-5005
6. Quick release clamps for use with pipes with an OD of 25-70mm (2) p/n 225-5007.
7. Quick release clamps for use with pipes with an OD of 51-127mm (2) p/n 225-5001.
8. *U1000MkII-HM only*: PT100 temperature sensors with 3m cable (2)
p/n 231-5005.
9. Modbus/M-Bus cable (optional) p/n 194-5040.

The kit also contains a copy of this manual.



Figure 2 Package Contents

1.4 Display

The U1000MKII display comprises:

- One 2-line x 16 character LCD with backlight
- Four tactile key switches
- Two LEDs

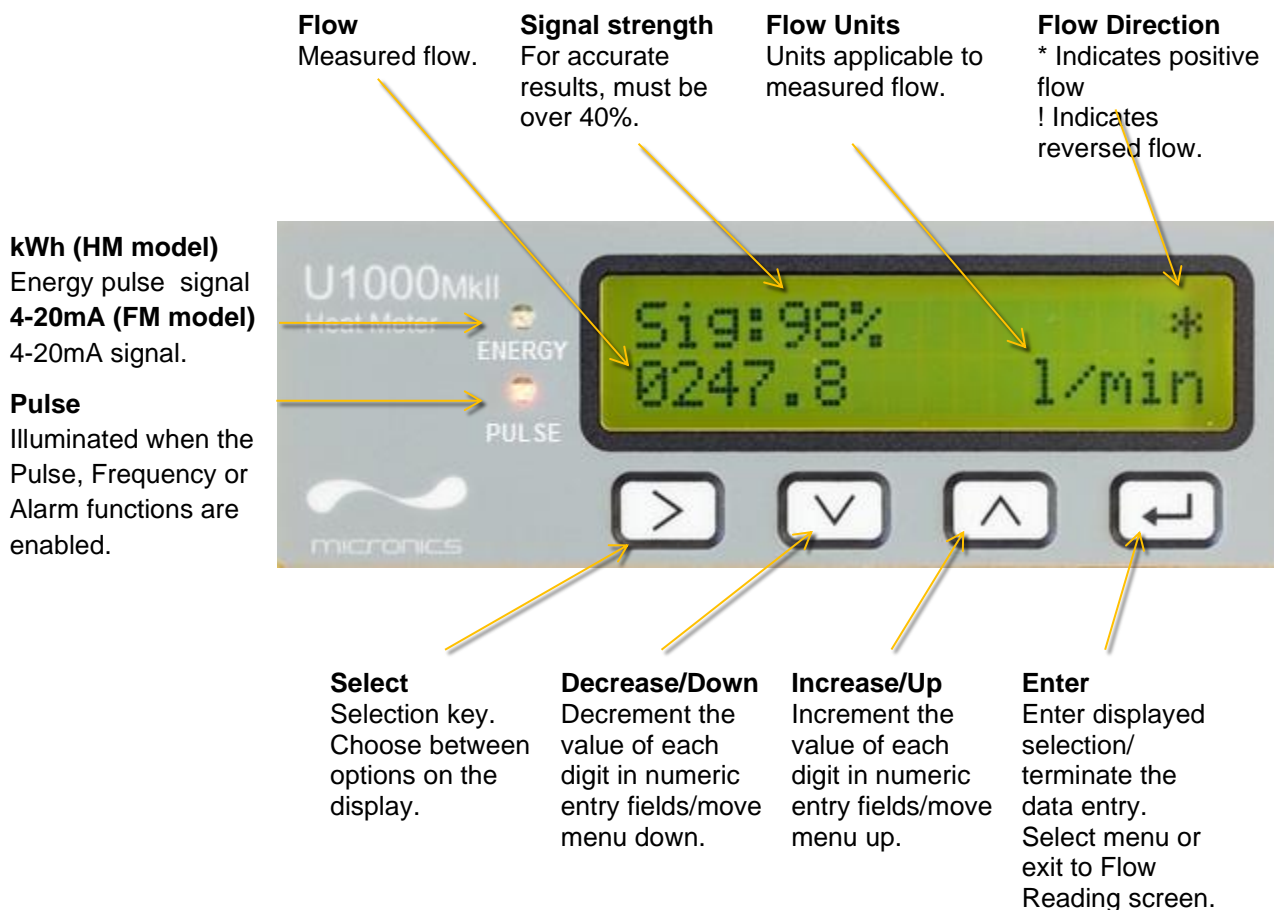

Figure 3 U1000MKII Display (HM model shown)

1.5 Quick Start Procedure

The following procedure summarises the steps required to set up the U1000MkII. Please refer to the referenced sections for full details.

1. Identify a suitable location for the U1000MkII on a straight length of pipe clear of bends and valves or similar obstructions (See pages 6 and 46).
2. Electronics Module:
 - a. Connect to a 12 to 24V DC or 24V AC power supply (7W/7VA minimum per instrument) using the Blue and Brown wires. (See page 7).
 - b. Switch on and program to determine the correct separation code (See page 15).
3. Sensor Assembly:
 - a. Loosen but do not remove the two sensor-holding screws to lower the flow sensors so they can slide along the Sensor Assembly's internal guide rail (see page 16).
 - b. Set the flow sensors to the correct separation (see page 16).
 - c. Tighten the sensor-holding screws.
 - d. Apply the gel pads to the sensors (see page 16).
 - e. Mount the Sensor Assembly on to the pipe using the supplied hose clip (see page 18).
If the pipe has an OD less than 60mm, use the adaptors provided (see page 17).
 - f. Remove the sensor-holding screws (See page 18).
4. Connect the two wires from the Sensor Assembly to the Electronics Module (see page 19).
DO NOT CLIP THE ELECTRONICS MODULE ONTO THE SENSOR ASSEMBLY AT THIS STAGE. THE ELECTRONICS MODULE CAN BE FULLY CLIPPED DOWN LATER ONCE ALL MEASUREMENTS HAVE BEEN CHECKED.
5. *U1000MkII-HM only*. Plug in the temperature sensors to the Electronics Module (see page 19) and attach the PT100 sensors to the flow and return pipes (see Section 2.1.1, page 6).
6. Check that flow readings can be obtained (see page 21).
7. Clip the Electronics Module to the Sensor Assembly and tighten the side screw to complete assembly (see page 22).

To use the Pulse Output features, see page 30.

To use the 4-20mA Output, see page 31 (*U1000MkII-FM only*).

To use the Modbus interface, see page 32. The address, data rate, and configuration of the instrument must be set using the Modbus Menu (see page 25). The default address is 1, the default data rate is 38400 baud, and the default Comms configuration is 8-None-2.

To use the M-Bus interface, see page 35. The primary address and data rate of the instrument must be set using the M-Bus Menu (see page 25). The default primary address is 1, and the default data rate is 9600 baud.

2 INSTALLATION

2.1 Identify Suitable Location

We recommend a location where there is a straight length of pipe with no bends, constrictions or obstructions within at least 10 times the pipe diameter upstream, and 5 times the pipe diameter downstream.

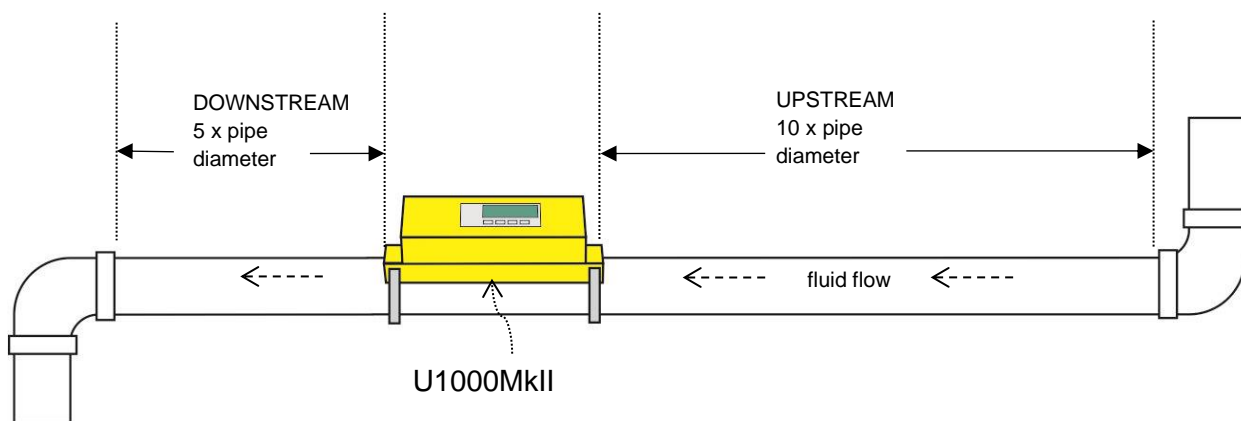

Figure 4 Identifying a suitable location

IMPORTANT: DO NOT EXPECT TO OBTAIN ACCURATE RESULTS IF THE UNIT IS POSITIONED CLOSE TO ANY OBSTRUCTION THAT DISTORTS THE UNIFORMITY OF THE FLUID FLOW PROFILE (SEE PAGE 46). MICRONICS LTD ACCEPTS NO RESPONSIBILITY OR LIABILITY IF PRODUCT HAS NOT BEEN INSTALLED IN ACCORDANCE WITH THESE INSTRUCTIONS.

2.1.1 Additional Considerations for Locating U1000MkII-HM

For optimum reliability on boiler applications, the flow measurement needs to be made on the cold side of the system. For optimum reliability in chiller applications, the flow measurement needs to be made on the warmer side of the system.

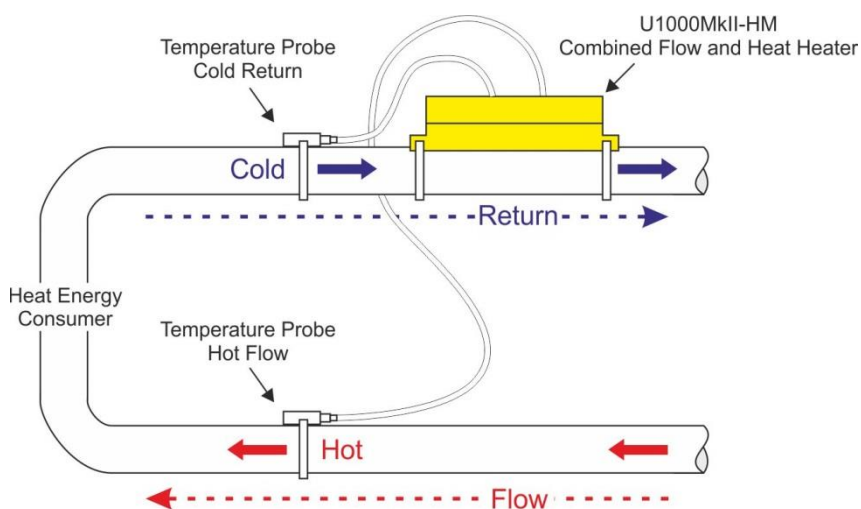

Figure 5 Typical setup of U1000MkII-HM for boiler applications

2.1.2 Clean the Pipe's Flow Sensor Contact Area

Prepare the pipe by degreasing it and removing any loose material or flaking paint in order to obtain the best possible surface. A smooth contact between pipe surface and the face of the sensors is an important factor in achieving a good ultrasound signal strength and therefore maximum accuracy.

U1000MKII-HM: The area of pipe where the temperature sensors are to be attached must be free of grease and any insulating material. It is recommended that any coating on the pipe is removed so that the sensor has the best possible thermal contact with the pipe.

2.2 Connect Power and Signal Cables

This section explains how to connect power and signal cables to the Electronics Module.

2.2.1 Power Supply

The U1000MKII will operate within the voltage range 12 - 24V DC/24V AC. The supply must have a minimum rating of 7W/7VA per instrument. Connect the external power supply to the Brown and Blue wires of the six-core cable.



External power supply must be class 2 rated.



IMPORTANT: IT IS THE RESPONSIBILITY OF THE INSTALLER TO CONFORM TO THE REGIONAL VOLTAGE SAFETY DIRECTIVES WHEN CONNECTING THE U1000MKII TO A POWER SUPPLY USING A MAINS-RATED TRANSFORMER.

The U1000MKII interface cable supplied is a 6-core cable for power, pulse output and 4-20mA (if fitted) connections.

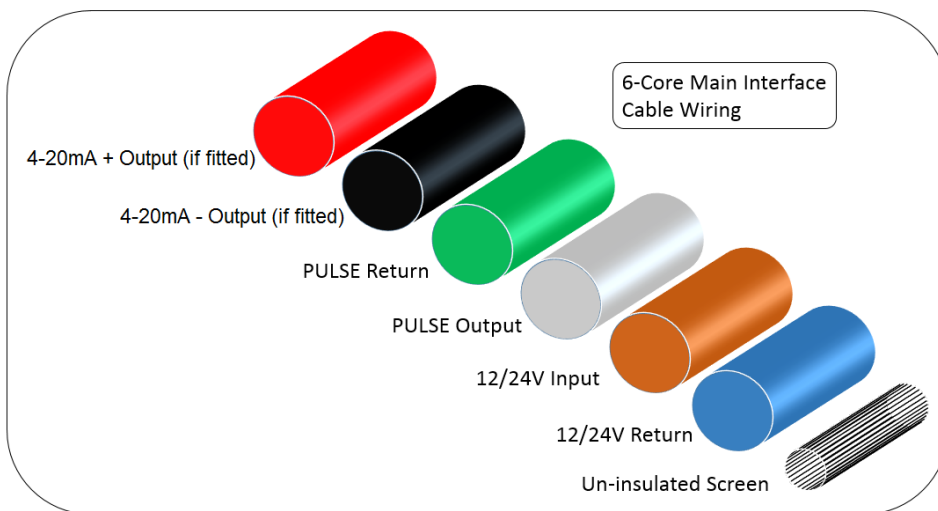



Figure 6 6-core main interface cable

The un-insulated wire is the connection to the screen of the cable and should be earthed for full immunity to electrical noise.

2.2.2 Pulse Output Connection

The isolated pulse output is provided by a SPNO/SPNC MOSFET relay which has a maximum load current of 500mA and maximum load voltage of 24V AC/DC.

 This output is suitable for SELV circuits only.

The pulse output is available at the White and Green wires. Electrically this is a Volt, or potential free contact and, when selected as a low flow alarm, is configurable NO/NC.

2.2.3 Current Output (U1000mkII-FM only, if fitted)

The isolated 4-20mA is a current source and can drive into a maximum load of 620Ω.

The 4-20mA current output is available at the Red and Black wires. The polarities are shown in Figure 6.

The alarm current due to a flow outside the range specified or due to a loss of signal is set at 3.5mA.

 This output is suitable for SELV circuits only.

2.2.4 Modbus Connections (if fitted)

A separate 4 core plug-in cable is provided for the Modbus connections.

This plugs into the Electronics Module near the power cable entry.

PIN	FUNCTION	COLOUR
1	MODBUS -ve	BLACK & BROWN
2	OPTIONAL GND	SCREEN
3	MODBUS +ve	BOTH WHITES
4	-	-

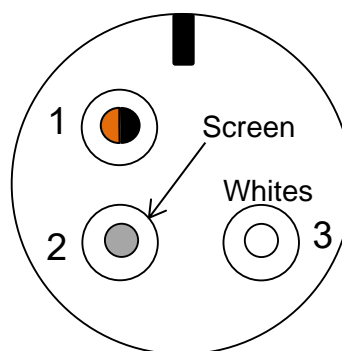

Figure 7 Modbus Connector Cable Part - Binder 99-9210-00-04 (Front View)

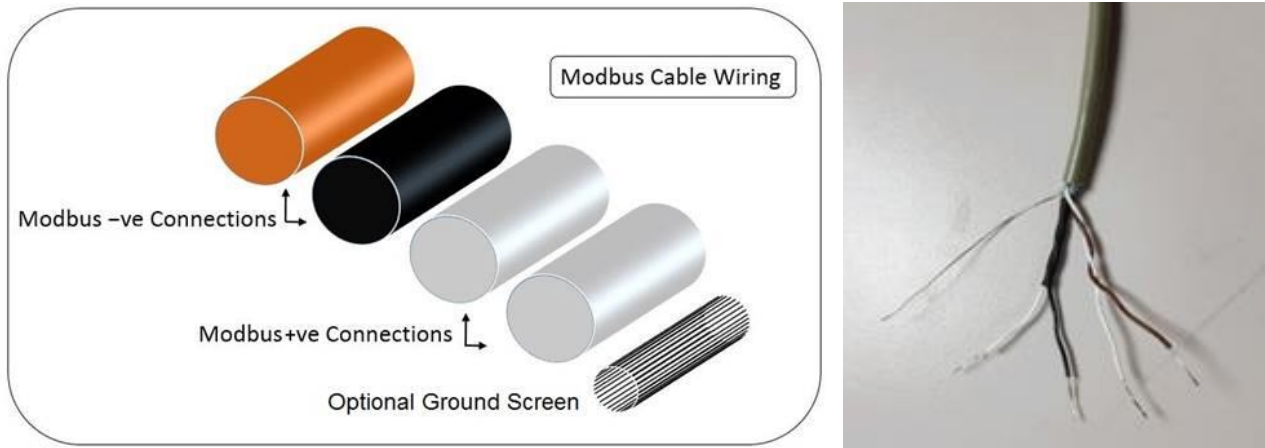

Figure 8 Modbus cable wiring

NOTE: ENSURE THE WHITE WIRES ARE CORRECTLY ASSOCIATED WITH THE BLACK & BROWN WIRES. THE BLACK/WHITE TWISTED PAIR IS FITTED WITH A BLACK SLEEVE TO DISTINGUISH BETWEEN THE BLACK/WHITE AND BROWN/WHITE PAIRS.

For reliable operation of a Modbus network the cable type and installation must comply with requirements in the Modbus specification document:

[“MODBUS over Serial Line Specification & Implementation guide V1.0”](#).



This output is suitable for SELV circuits only.

For full immunity to electrical interference the screen of the power/pulse output cable and Modbus cable should be connected to Earth.

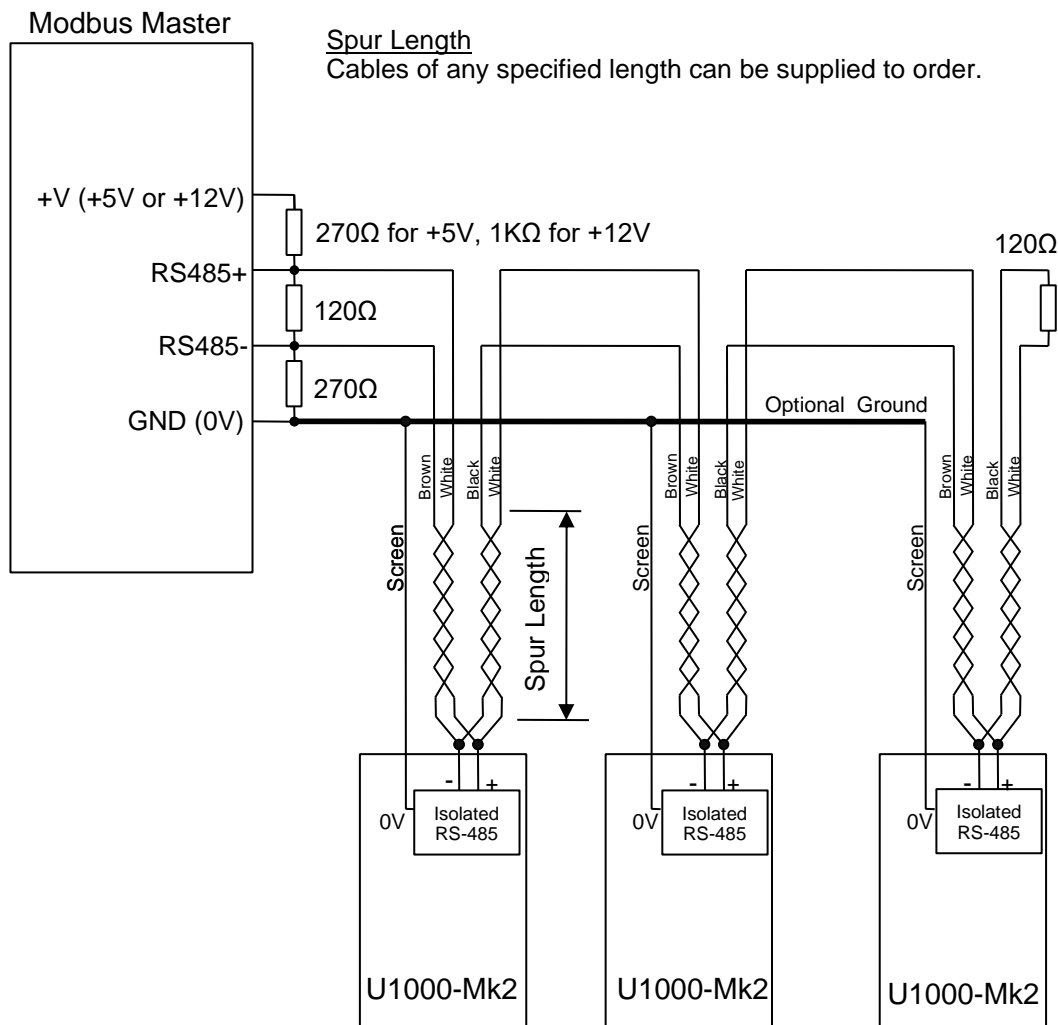

Figure 9 Modbus wiring diagram

2.2.5 M-Bus Connections (if fitted)

A separate 4 core plug-in cable is provided for the M-bus connections.

This plugs into the Electronics Module near the power cable entry.

PIN	FUNCTION	COLOUR
1	M-BUS	BLACK & BROWN
2	OPTIONAL GND	SCREEN
3	M-BUS	BOTH WHITES
4	-	-

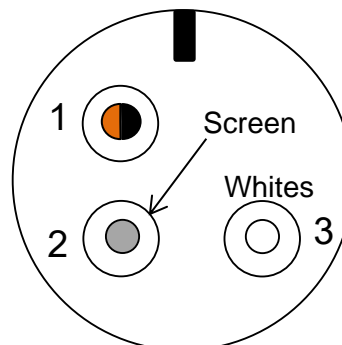

Figure 10 M-Bus Connector Cable Part - Binder 99-9210-00-04 (Front View)

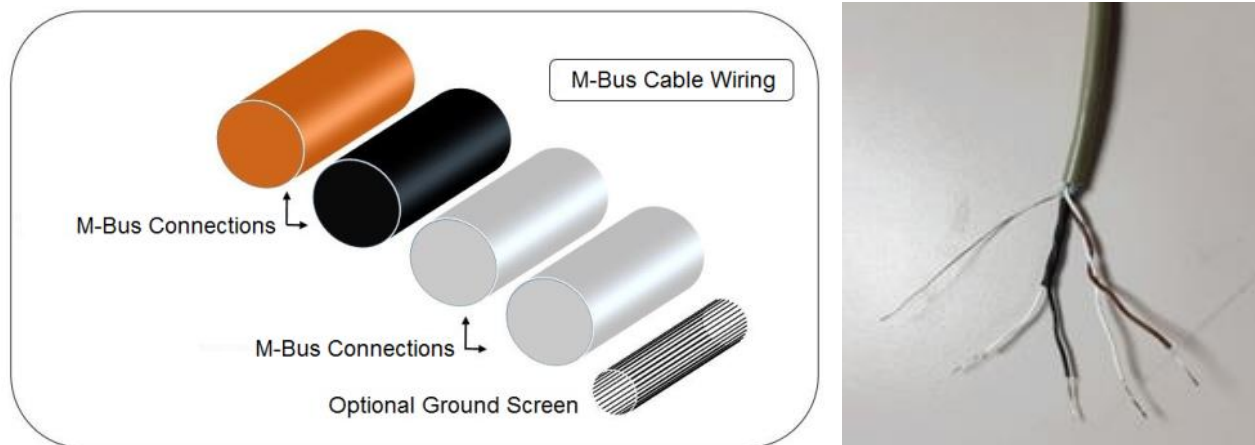

Figure 11 M-Bus cable wiring

NOTE: ENSURE THE WHITE WIRES ARE CORRECTLY ASSOCIATED WITH THE BLACK & BROWN WIRES. THE BLACK/WHITE TWISTED PAIR IS FITTED WITH A BLACK SLEEVE TO DISTINGUISH BETWEEN THE BLACK/WHITE AND BROWN/WHITE PAIRS.

For reliable operation of a M-bus network the cable type and installation must comply with requirements in the M-bus specification document:

[Meter Communication Twisted Pair Baseband \(M-Bus\) Physical and Link Layer](#)

For full immunity to electrical interference the screen of the power/pulse output cable and M-Bus cable should be connected to Earth.

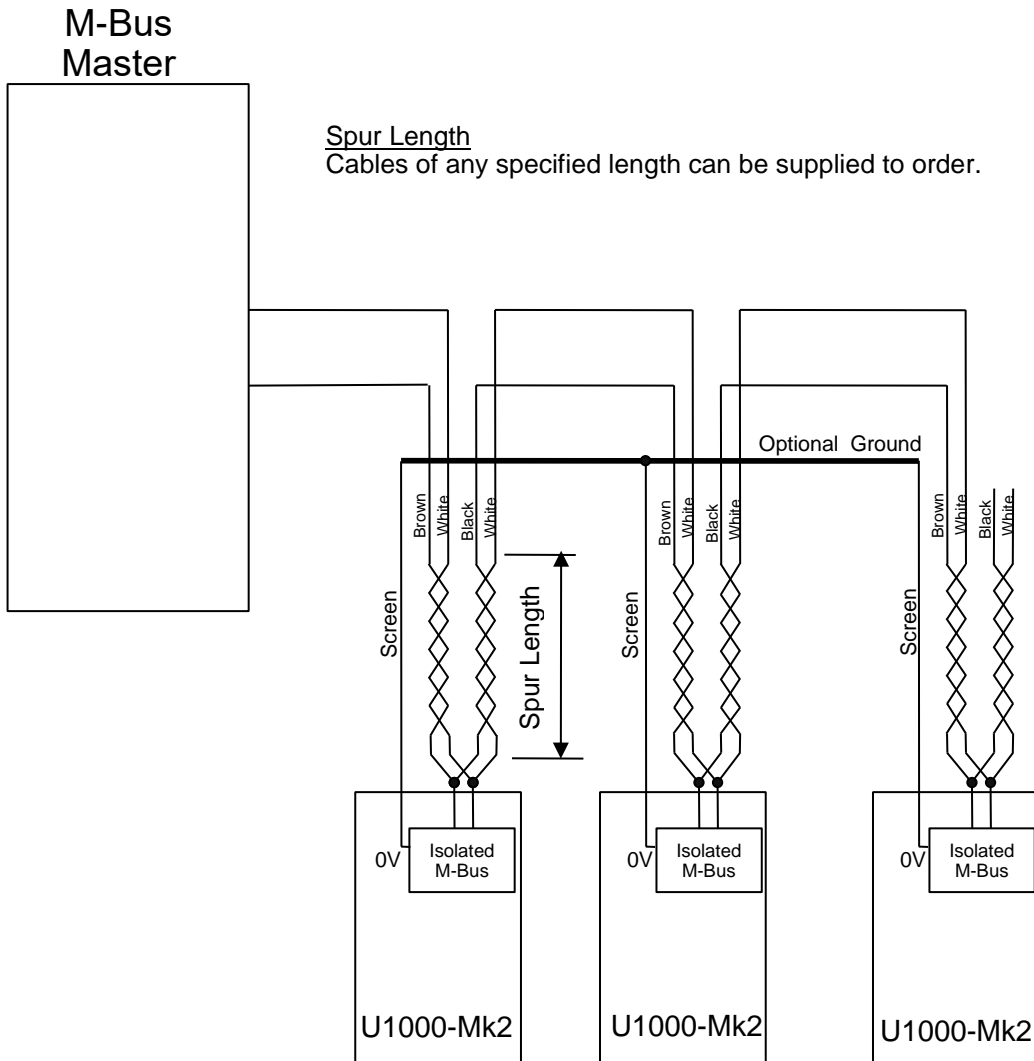

Figure 12 M-Bus wiring diagram

2.2.6 Temperature Sensor Probes (U1000-HM only)

Two separate 4-core plug-in cables are provided for the Temperature Sensor Probes connections. These plug into the right-hand side of the Electronics Module.

U1000-HM Temperature Probe Wiring

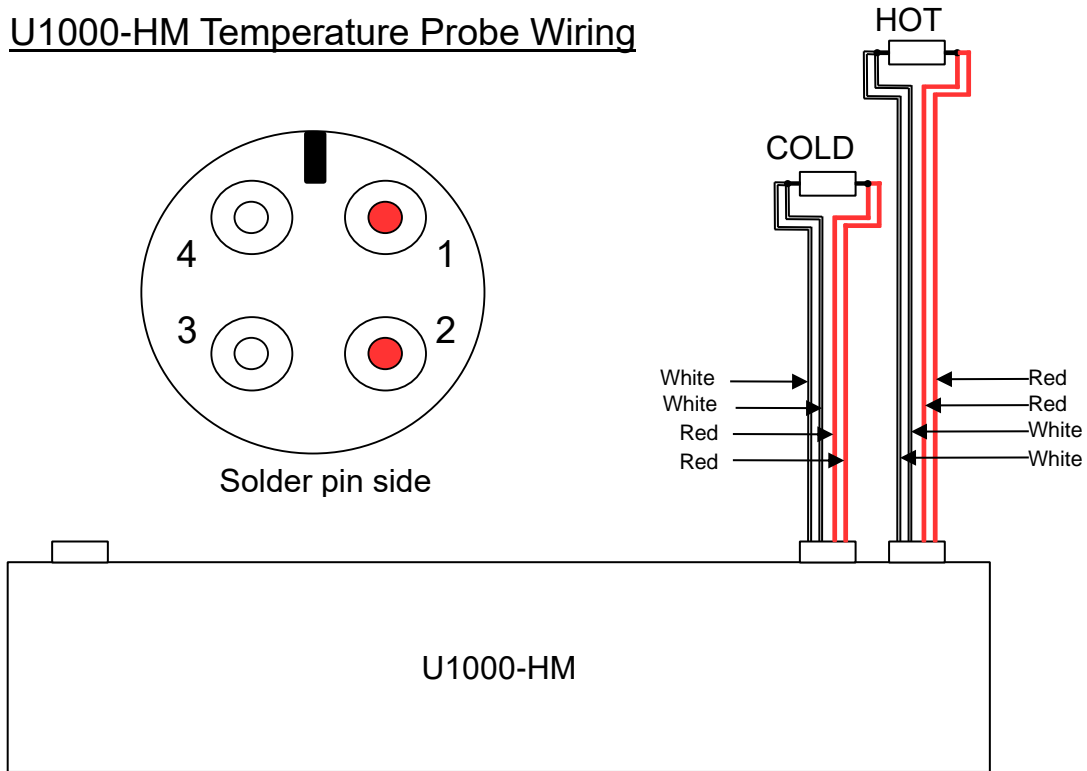

Figure 13 U1000-HM Temperature Probe Wiring

2.3 Switch On

The initial screen sequence is different for the FM and HM models.

2.3.1 U1000MKII-FM

Switch on the power to the Electronics Module. A Micronics start-up screen is displayed for 5 seconds followed by hardware and software version information.

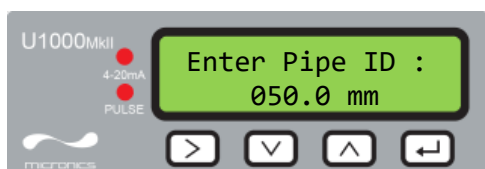



You are then prompted to enter the internal diameter of the pipe:

Use the ,  and  keys to change the value.

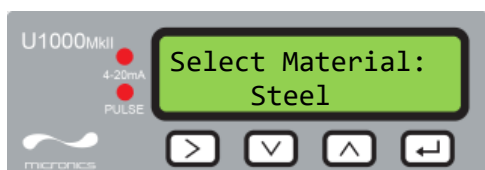
Press  to confirm the value.



Select the pipe material by using the  and  keys to scroll through the list.

Press  to confirm the material.

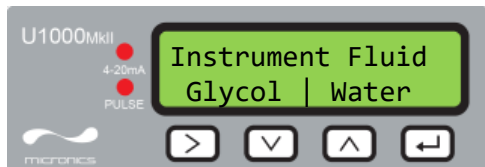

Select the fluid using the  key.

Press  to confirm the fluid name.



If the fluid temperature is in the range 2°C to 40°C select "COLD". If the fluid temperature is in the range 40°C to 85°C select "HOT".



The unit now shows the correct flow sensor separation (in this case, "B2") for the chosen values of pipe ID, pipe material and fluid.

Make a note of the separation code.

All subsequent start-ups will use the same configuration.



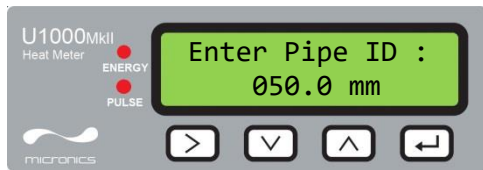

Continue with the installation of the Sensor Assembly (see page 16).

2.3.2 U1000MKII-HM



Switch on the power to the Electronics Module. A Micronics start-up screen is displayed for 5 seconds followed by hardware and software version information.

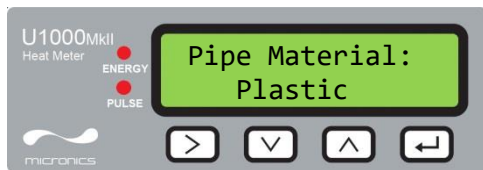

You are then prompted to enter the internal diameter of the pipe:

Use the ,  and  keys to change the value. Press  to confirm the value.



Select the pipe material by using the  and  keys to scroll through the list.

Press  to confirm the material.



Select the instrument setting using . The unit is preconfigured for Heating applications.

Press  to confirm the setting.

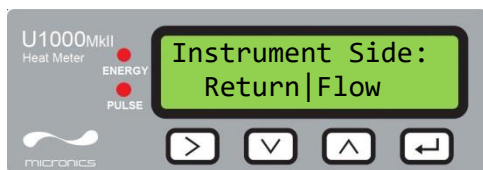



Select which side the electronics unit is installed using: .

The unit is preconfigured for *Return*.

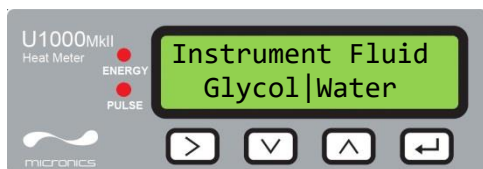
Press  to confirm the setting.



Select the fluid using .

Press  to confirm the fluid name.



If the fluid temperature is in the range 2°C to 40°C select “COLD”. If the fluid temperature is in the range 40°C to 85°C select “HOT”.



The unit now shows the correct flow sensor separation (in this case, “B-2”) for the chosen values of pipe ID, pipe material and fluid.

Make a note of the separation code.

All subsequent start-ups will use the same configuration

Continue with the installation of the Sensor Assembly (see page 16).

2.4 Adjust Flow Sensor Separation

Using the separation code displayed by the Electronics Module (see page 14/15), take the Sensor Assembly and adjust the flow sensor separation accordingly:

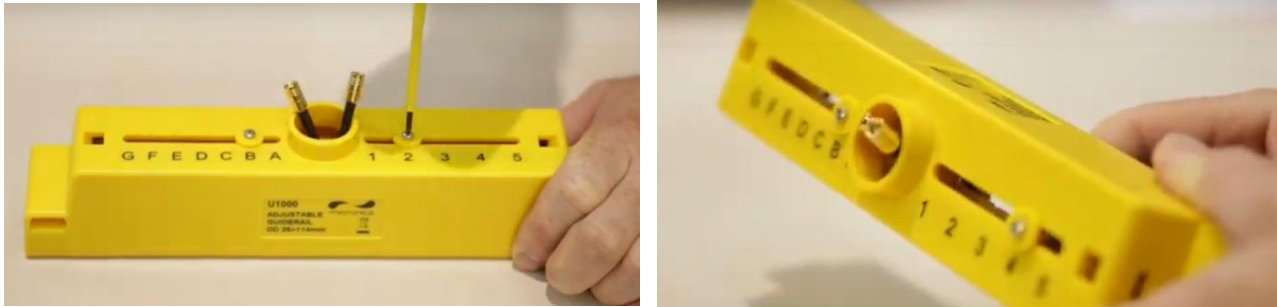

Figure 14 Loosen the flow sensor-holding screws (left); slide to correct position (right)

1. Undo the screws 2-3 turns, sufficiently to loosen the flow sensors and allow sideways movement. DO NOT fully unfasten or remove the screws at this stage.
2. Slide the flow sensors to the positions indicated on the display (e.g. “D5”).
3. With the flow sensors in the correct positions, tighten the sensor-holding screws so that the sensors are secure.

2.5 Apply Gel Pads

1. Apply a gel pad centrally onto the bases of each of the two flow sensors.
2. Remove the covers from the gel pads.
3. Ensure there are no air bubbles between each pad and sensor base.



Figure 15 Applying the gel pads

2.6 Clamp Sensor Assembly to Pipe

The next step involves clamping the Sensor Assembly onto the pipe. Ensure that you have selected a suitable location (see pages 6 and 46) and that the pipe is clean (see page 7). If you are installing the unit on a pipe with an outside diameter less than 60mm use one or more of the adaptors supplied with the unit.

2.6.1 Pipe Adaptors

The diagrams below show how the adaptors are fitted. The top 'V' shaped adaptor clips onto the ends of the Sensor Assembly and this should be used with all pipes with an outside diameter less than 60mm.

Additionally, for pipes with an outside diameter less than 40mm, a second adaptor should also be used. This fits underneath the pipe as shown below.

IMPORTANT: DO NOT USE THESE ADAPTORS IF THE PIPE HAS AN OUTSIDE DIAMETER GREATER THAN 60MM.

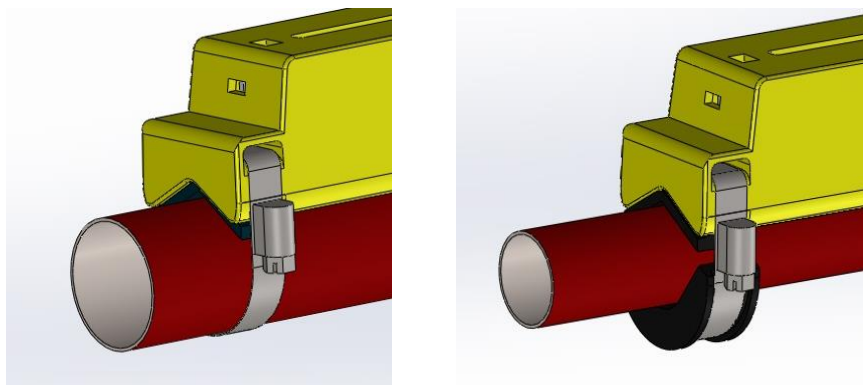

Figure 16 Pipe adaptors in position: 40-60mm OD (left), less than 40mm OD (right)

2.6.2 Attaching to Pipe

1. For pipes with an outside diameter less than 60mm, attach the black clips to the bottom of the Sensor Assembly as shown below.



Figure 17 Attaching pipe adaptor

2. Place the Sensor Assembly on pipe.
3. For pipes with an outside diameter less than 40mm, position the curved adaptor under the pipe.

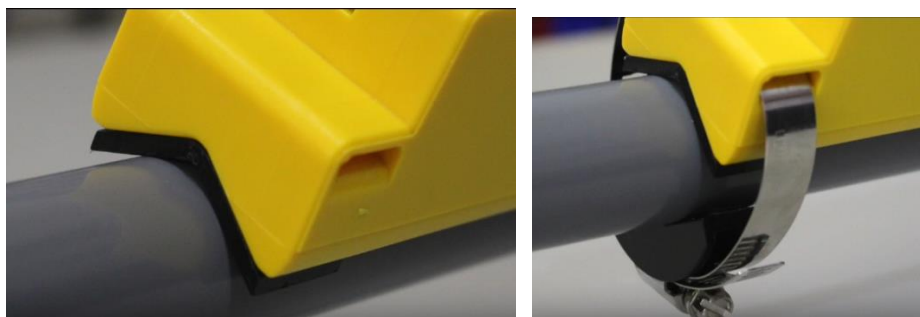

Figure 18 Clamping pipe adaptor to pipe with OD less than 40mm

4. Using the hose clips provided, clamp the Sensor Assembly (and adaptors, if used) to the pipe at an angle of 45° to the top of the pipe. Experience has shown that the most consistently accurate results are achieved when the unit is mounted at this angle (see page 46). This minimises the effect of any flow turbulence resulting from entrained air along the top of the pipe and sludge at the bottom.



Figure 19 Sensor Assembly clamped at 45°

2.7 Remove Sensor-Holding Screws

Release and remove the sensor-holding screws. The flow sensors are spring-loaded to ensure good contact with the pipe surface.

NOTE: THE SENSOR-HOLDING SCREWS AND WASHERS SHOULD BE KEPT IN A SAFE PLACE IN CASE IT IS NECESSARY TO RELOCATE THE UNIT (SEE PAGE 43).



Figure 20 Removing sensor-holding screws

2.8 Connect Electronics Module

1. Ensure that the power is switched off.
2. Connect the Electronics Module (wired as described on page 7). The two leads can be connected either way round.

IMPORTANT: DO NOT CLIP THE ELECTRONICS MODULE ONTO THE SENSOR ASSEMBLY UNTIL YOU HAVE CHECKED OPERATION.

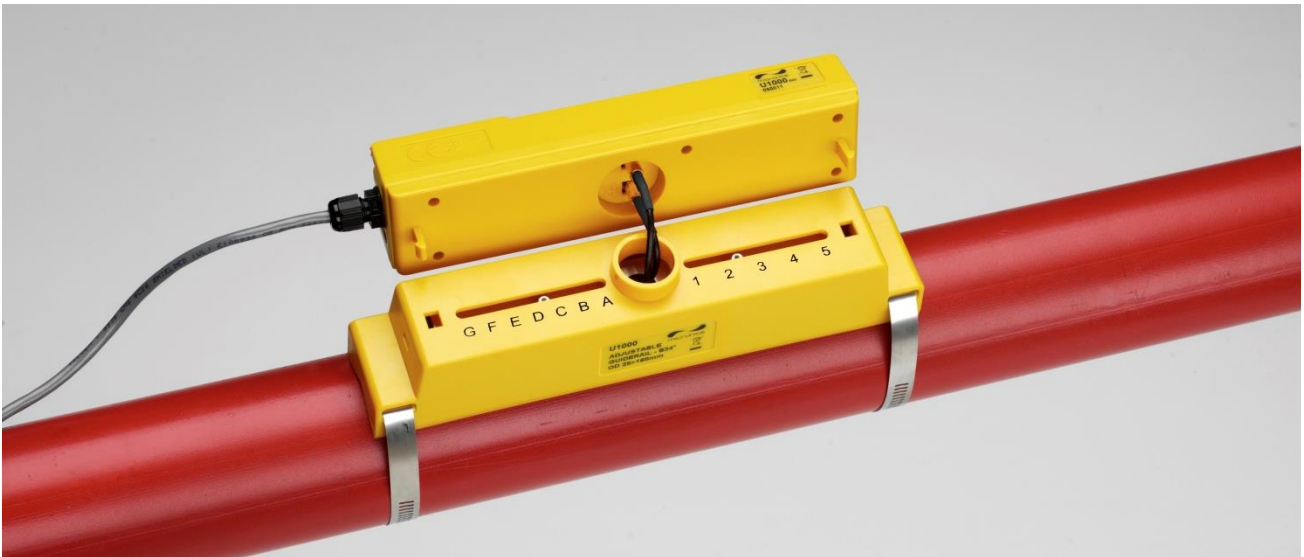

Figure 21 Connecting the Electronics Module

2.9 Attach the Temperature Sensors (U1000MKII-HM Only)

IMPORTANT: THE TEMPERATURE SENSORS MUST BE BALANCED BEFORE INITIAL USE, USING THE PROCEDURE DESCRIBED BELOW AND USED WITH THE CABLE LENGTH SUPPLIED. EXTENDING OR SHORTENING THE CABLES WILL NEGATE THE CALIBRATION OF THE SENSORS.

The temperature sensors must be located at the input and output of the system that is being monitored. The area of pipe where they are to be attached must be free of grease and any insulating material. It is recommended that any coating on the pipe is removed so that the sensor has the best possible thermal contact with the pipe.

The sockets on the Electronics Module are marked **Hot** and **Cold** (see Figure 22). This defines the location of the temperature sensors on installations where heat is being extracted from the system.



Figure 22 Temperature Sensor connectors on the Electronics Module

To ensure an accurate temperature differential:

1. Plug the temperature sensors into the Electronics Module and place them touching each other for 1 minute.
2. Enter the password controlled menu and scroll to the *Calibration* sub-menu (see page 28).
3. Press the Enter key until the *Zero Temp Offset* screen is displayed (see page 28).
4. Select **Yes** and press the Enter key to display the *Attach Sensors* screen.
5. Press the Enter key again and wait for instrument to return to the *Zero Temp Offset* screen.
6. Switch off the power to the Electronics Module.
7. Complete the installation of the temperature sensors. The temperature sensors have a cut out profile to locate them; they are then anchored using the supplied cable ties. The cable ties should not be over tightened or the sensors may be damaged. If the sensors are located under pipe-lagging then ensure this does not put a strain on the sensor cables.
8. Tie down the sensor cables.

2.10 Normal Operation

The screen sequence is different for the FM and HM models.

2.10.1 U1000MKII-FM

Press .

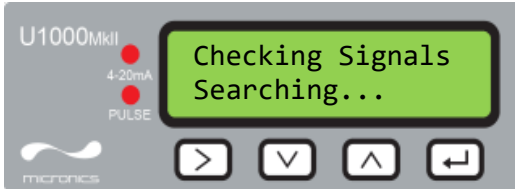

The unit checks for a valid flow signal.



If a valid signal is found, signal strength and flow rate are displayed. The signal strength should be at least 40% for reliable operation.

2.10.2 U1000MKII-HM

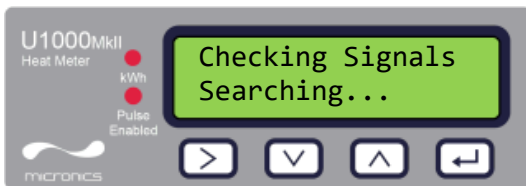

Press .

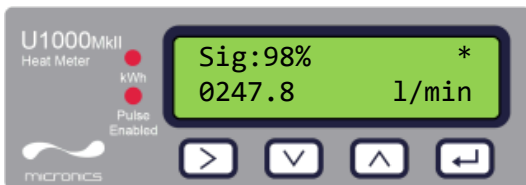

The unit checks for a valid flow signal.



If a valid signal is found, signal strength and flow rate are displayed. The signal strength should be at least 40% for reliable operation.

Press the  and  keys to scroll to the *Total Flow*, *Temperature dT*, *Total Energy* and *Instant Power* screens.

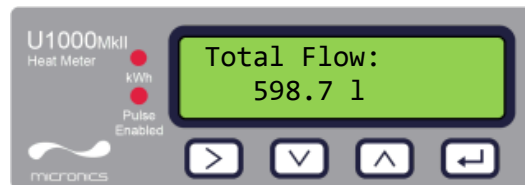
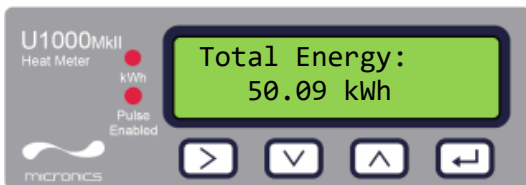
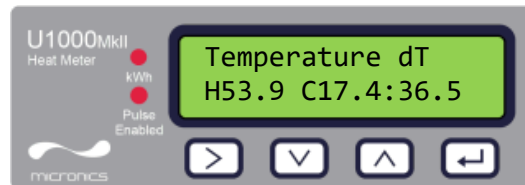
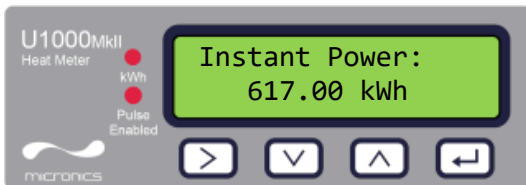

2.10.3 Troubleshooting the Flow Reading

The direction of flow when powered up will be taken to be the positive flow direction. The pulse output will relate to the flow in this direction. If the flow is reversed then the flow rate will still be displayed but the activity indication will change from an asterisk to an exclamation mark and no pulses will be generated.

If the flow value is displayed as “-----” this indicates that there is no usable signal from the flow sensors.

The cause of this could be:

- Incorrect pipe data
- Sensor not in contact with the pipe
- Air in the liquid/pipe
- No Gel pad or grease on the sensor
- Very poor pipe condition-surface/inside

2.11 Clip Electronics Module to Sensor Assembly

If the unit is working correctly, clip the Electronics Module onto the Sensor Assembly. Secure in place with the screw on the right side (see page 43, Figure 24).

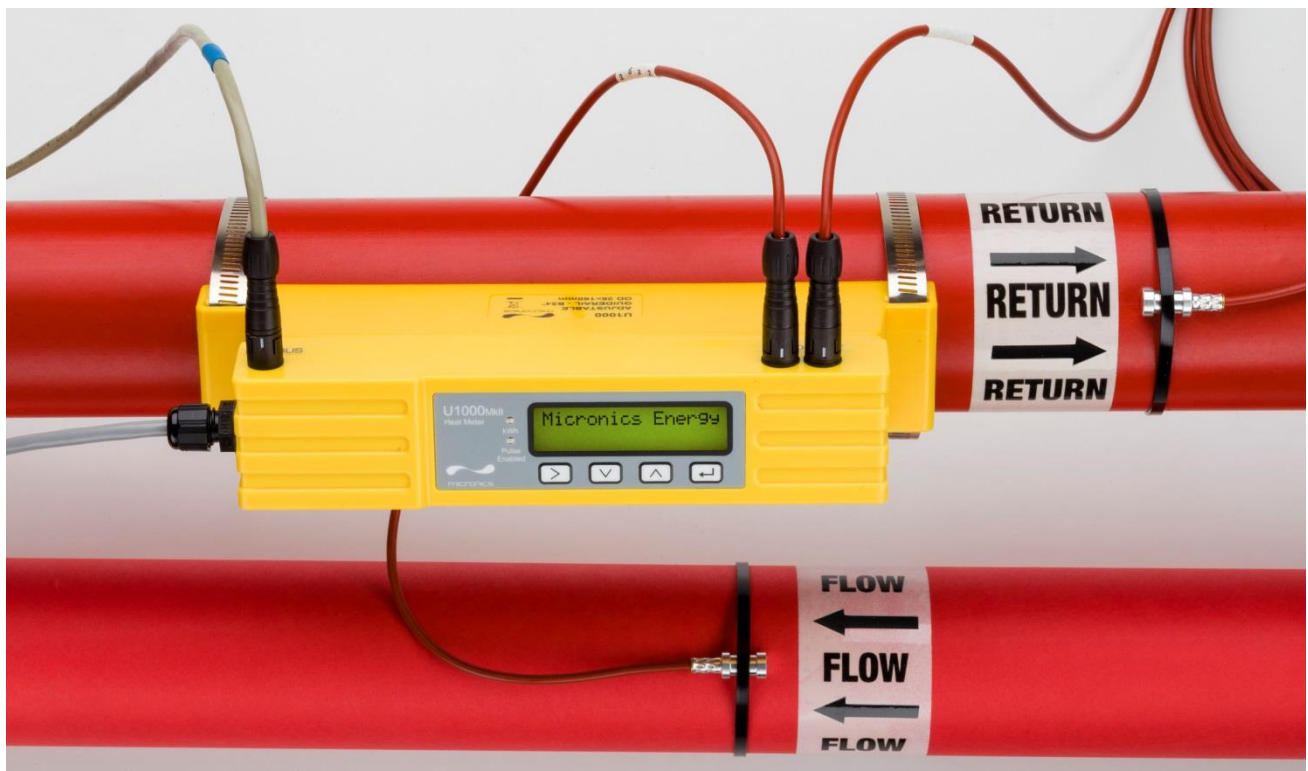

Figure 23 Fully assembled U1000mkII-HM unit

3 MENUS

The password-protected menus allow you to change the default settings:

- Setup (see page 24)
- Modbus (see page 25) – *if Modbus output option installed*
- M-Bus (see page 25) – *if M-Bus output option installed*
- Current Output (see page 25) – *U1000MkII-FM only*
- Pulse Output (see page 27)
- Calibration (see page 28)
- Volume Total (see page 28)
- Exit

For troubleshooting purposes, an additional Diagnostics menu is available from the main *Flow Reading* or *Total Flows* screens (see page 29).

3.1 Accessing the Menus

Ensure that the instrument is in *Flow Reading*, *Total Flow*, *Temperature dT*, *Total Energy*, *Instant Power* or *Total Flow* modes, then press .

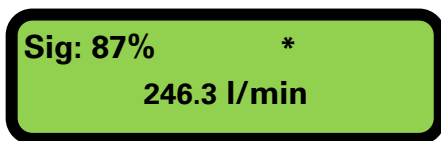



Enter 71360 and then press .





The Setup Menu is displayed.



Use  and  to cycle through the menu sections.

Press  to open a menu.

To return to the Flow Reading screen, scroll to **Exit** and press .

Within a menu, press  to change between two displayed options (the active setting flashes) or, if there are several options, use  and  to cycle through the possible values.

Press  to confirm a value and display the next setting (or exit the menu if it is the last option).

3.2 Setup Menu

If “inches” is selected for the *Select Dimensions* option, then the temperatures will be displayed in °F and the energy values will be in kBTUs.

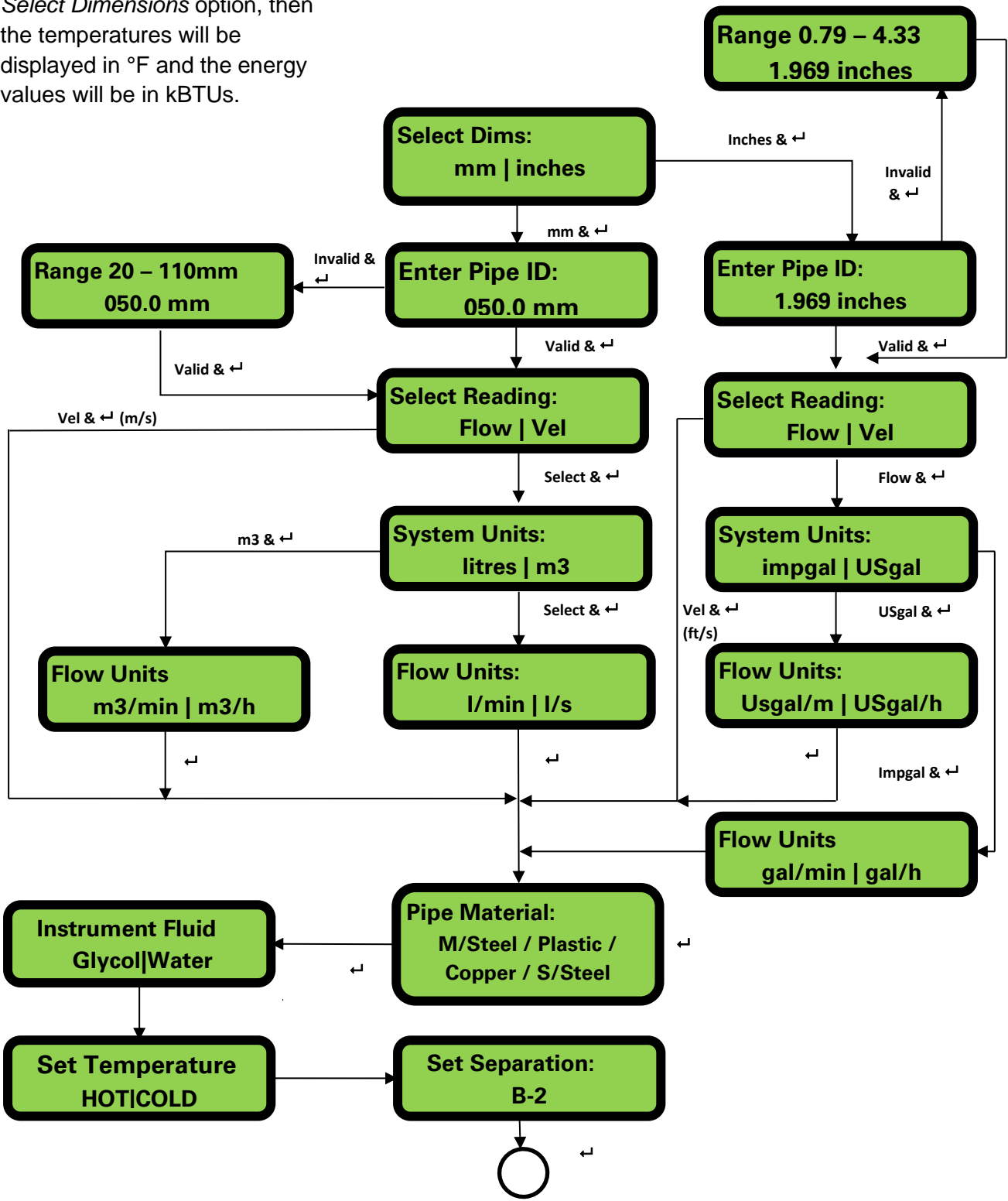

3.3 Modbus Menu

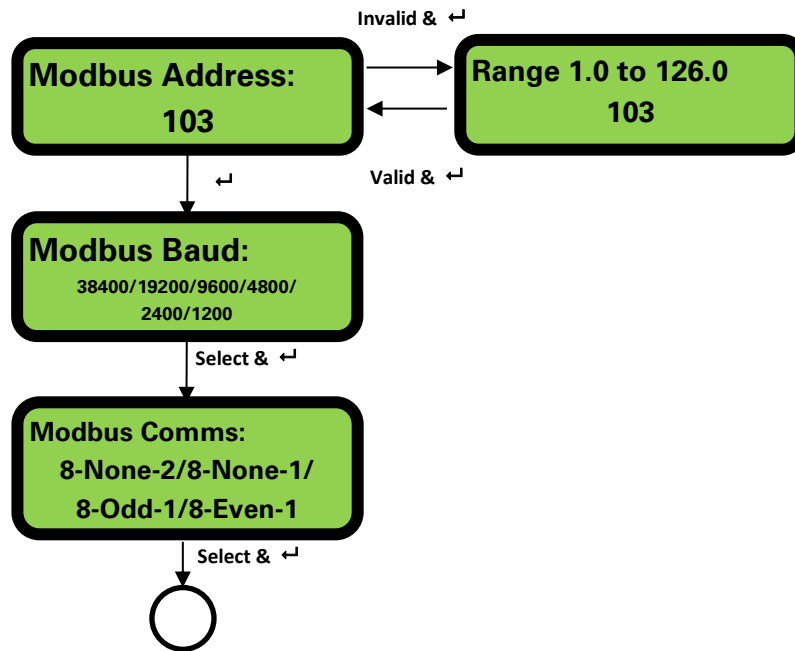

3.4 M-Bus Menu

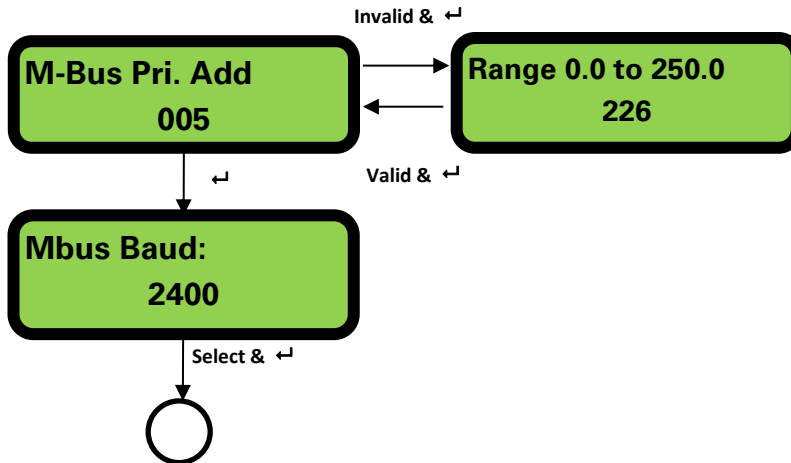

3.5 Current Output Menu (U1000MKII-FM only)

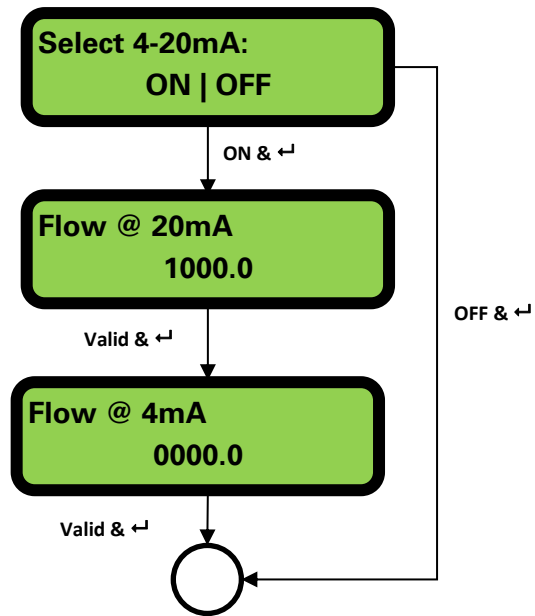

3.6 Pulse Output Menu

NOTE: SCREENS WITHIN THE RED BOX ARE ONLY SHOWN ON U1000MKII-HM MODELS.

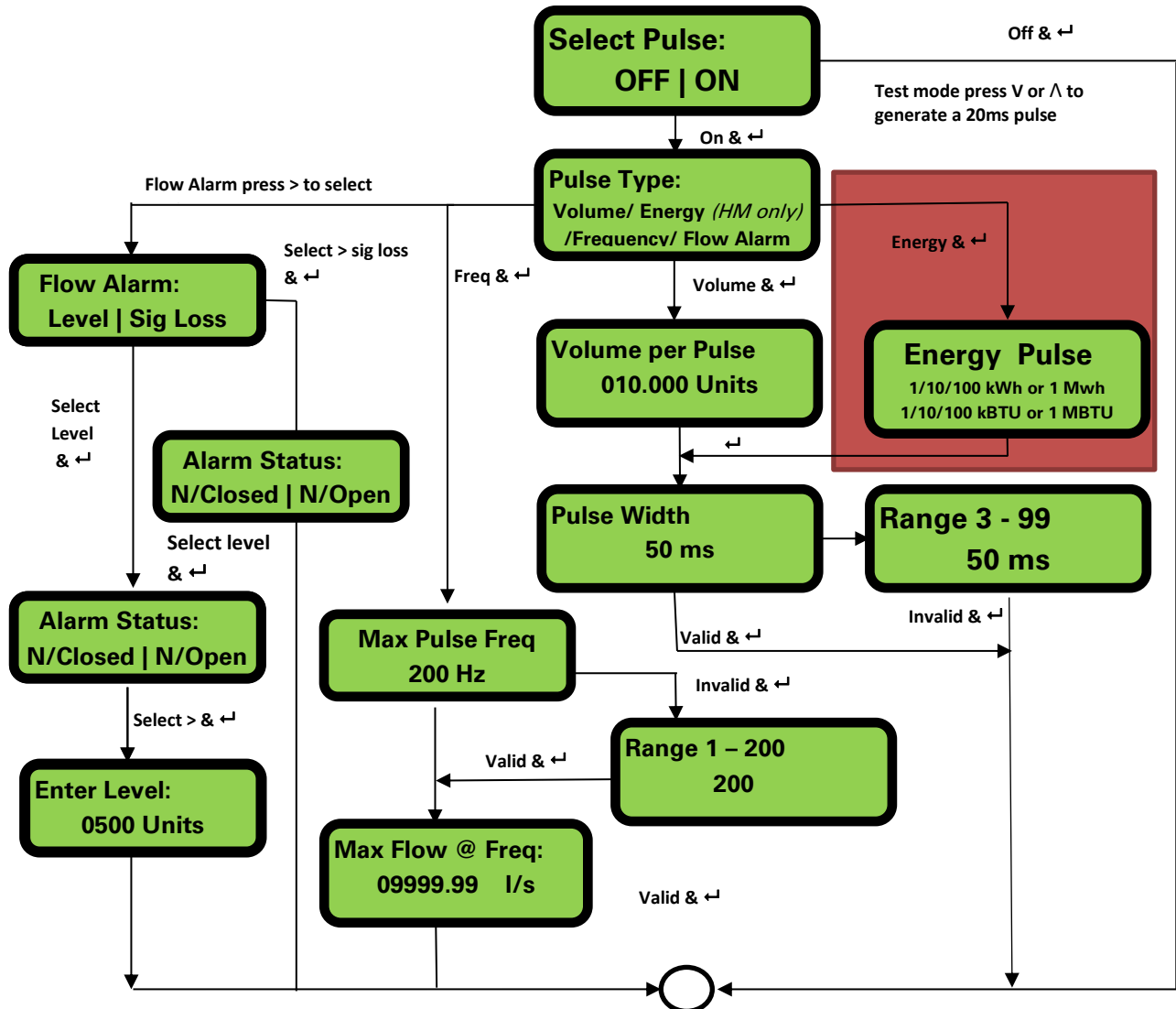

3.7 Calibration Menu

NOTE: SET 'ZERO CUT-OFF' TO ZERO BEFORE SETTING 'ZERO OFFSET' THEN GO BACK TO SET 'ZERO CUT-OFF'.

NOTE: SCREENS WITHIN THE RED BOX ARE ONLY SHOWN ON U1000MKII-HM MODELS.

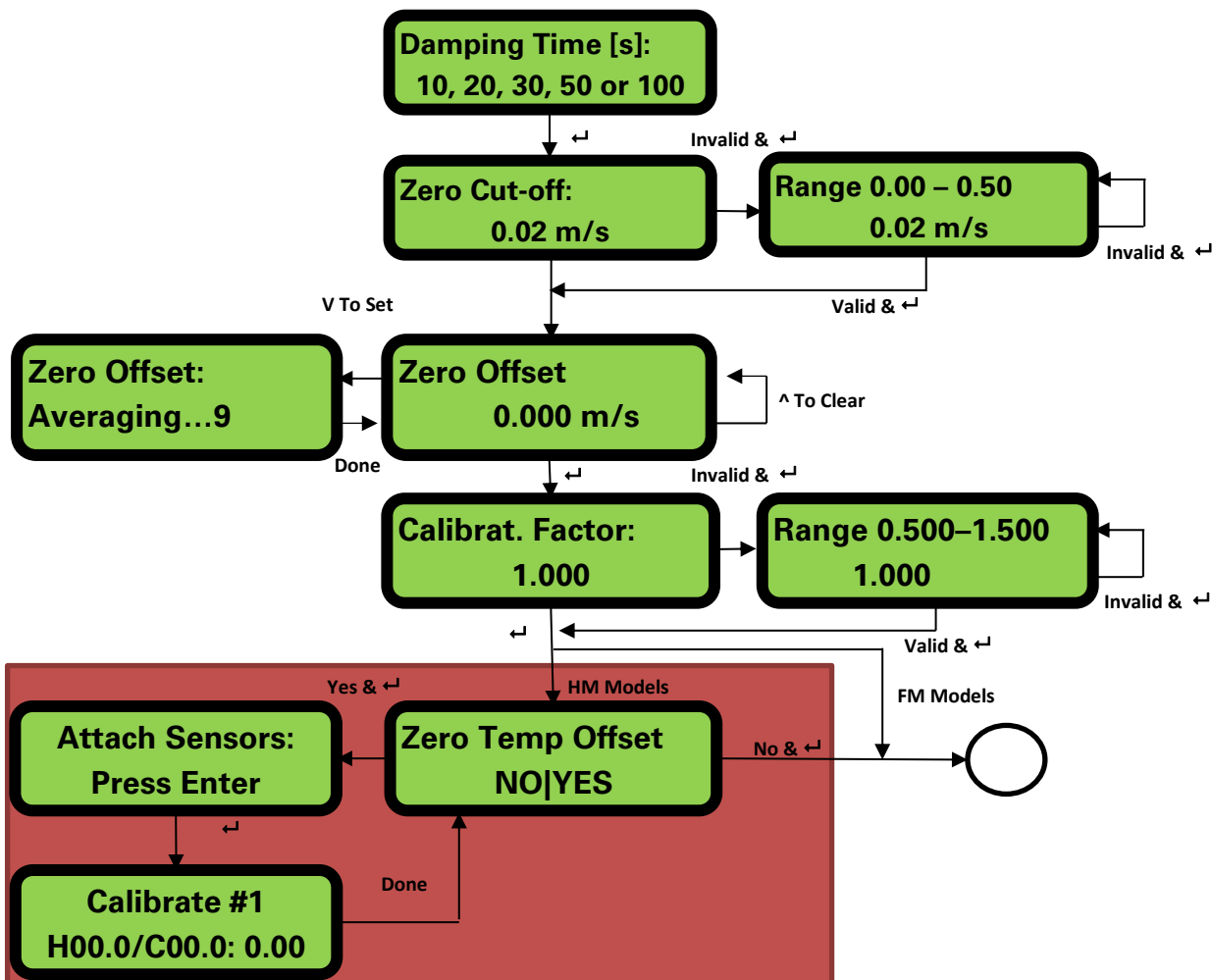

3.8 Volume Total Menu

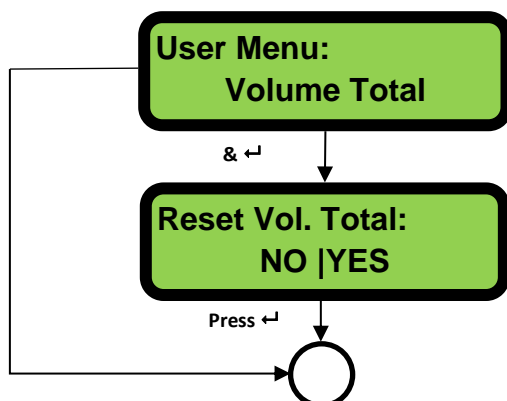

3.9 Diagnostics Menu

The diagnostics menu provides some additional information about the flowmeter and its setup. The menu can be accessed by pressing the **>** key from the main flow-reading screen. Press the **^** and **∨** keys to move between the diagnostics screens.

Press **↵** to exit the Diagnostics menu.

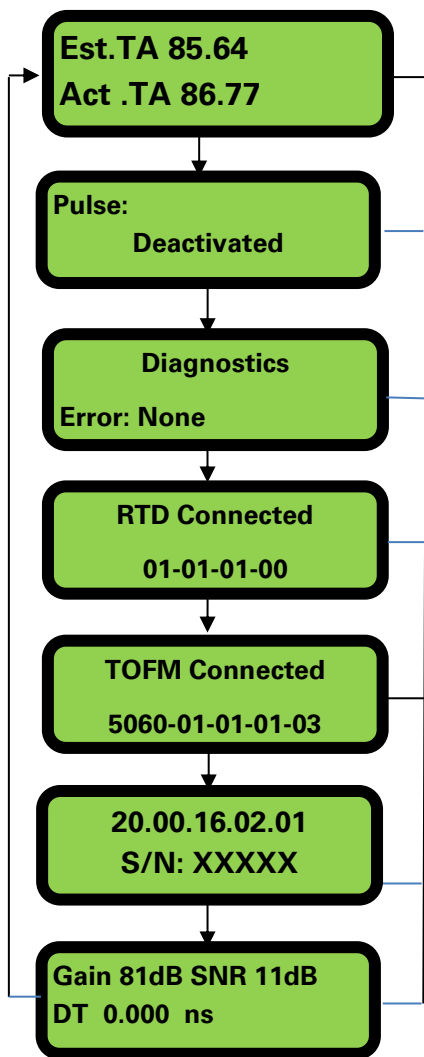

The Estimated TA (Time of Arrival) and Actual TA show the theoretical and measured transit times. If the actual value is displayed as 9999.99 then a usable signal could not be detected.

Displays the pulse status (for example): Deactivated, Volume 0.000 litres, Signal Loss, Alarm(On) 500.0 l/min, Alarm(Off) Signal Loss, Frequency 100.00 Hz.

This screen will display the Errors. A number between 0-255 will be displayed. If no errors reported "None" is displayed.

The RTD board's software version is shown on the lower line. The upper line shows its status.

The flow board's software version is shown on the upper line. The lower line shows its status.

The unit's software version is shown on the upper line. The lower line shows the unit's serial number.

Gain – a decibel number between -5dB and 80dB – *lower is better*, should be around 40dB or below. Above 60dB need to question the installation. Signal/Noise ratio in dB, scale is 0 to 80dB – *higher is better*. Below 20 question the installation. The lower line shows the current time differential between the upstream and downstream signals.

4 OUTPUTS

4.1 Pulse Output

Pulse output can be set up to operate one of five modes:

- Volumetric
- Energy (U1000MKII-HM only)
- Frequency
- Low Flow Alarm
- Loss of Flow (Signal) Alarm

The Alarm functions allow you to set the alarm switch to *Normally Open* or *Normally Closed*.

4.1.1 Volumetric Pulse

The U1000MKII default pulse width is set to 50ms which represents half of one pulse cycle. A 50ms pulse width is required for most mechanical counters.

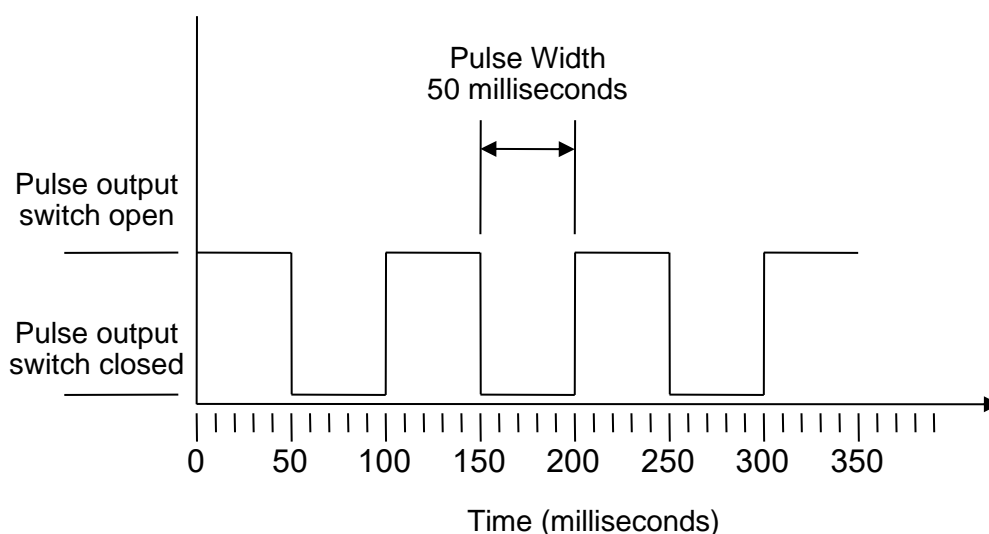

Default Pulse Width

Formula to obtain Volume per Pulse based on a (default) 50ms pulse width:
 Volume per Pulse \geq maximum flow rate (in litres per minute) / 600

Example for maximum flow rate of 500 l/min:

Volume per Pulse \geq 500 l/min / 600 = 0.833 litres per pulse

Rounding up to nearest whole litre:

Set **Volume per Pulse** to **1 litre**.

4.1.2 Frequency Mode

In Frequency mode, the output frequency is proportional to the flow rate within a specified frequency range of 1 – 200Hz.

4.1.3 Energy Pulse (U1000MkII-HM only)

When the *Pulse Output* is set to **Energy**, the kWh LED will be permanently illuminated. Choose from 1,10,100kWh or 1MWh when in metric mode and 1,10,100kBTU or 1MBTU in imperial mode. Each pulse represents an amount of energy e.g. 1kWh. The same limitation on maximum pulse rate applies as detailed in the Volumetric Mode. Again a larger unit of energy per pulse or a smaller pulse width may be required.

4.1.4 Flow Alarm - Low Flow

For the Low Alarm the user can set a range between 0 and 9999 (no decimal places), in the same units being used to measure flow. The default setting is normally open, but the user can select between N/O and N/C. There is a 2.5% hysteresis on the switching of the output. Once the low flow alarm is activated, the flow rate must rise by 2.5% more than the set value to deactivate the alarm again.

4.1.5 Flow Alarm – Signal Loss

If the flow reading (signal) is lost, as indicated by the flow rate being displayed as “-----“, the alarm will be triggered. The default setting is normally open, but the user can select between N/O and N/C.

4.2 4-20mA Current Output (U1000MkII-FM only)

The default 4-20mA output setting is OFF, and the 4-20mA LED on the keypad will not be illuminated. The default flow for 4mA is 0. This can be changed, see page 26.

If the flow reading is greater than that set as the 20mA value, or there is negative flow, or no flow signal can be detected, then an alarm current of 3.5mA will be generated.

NOTE: THE 4-20MA CURRENT OUTPUT IS FACTORY CALIBRATED.

4.3 Modbus (if fitted)

The Modbus RTU interface is configured via the Modbus sub menu.

- Float byte order –AB CD – Big endian – MSB first.
- The data rate can be selected in the range 1200 to 38400 baud.
- The address can be set in the range 1 to 126.
- Minimum Polling Rate 1000ms (1sec). Time out after 5 seconds.
- The U1000 MKII will only respond to Modbus requests while operational, while the flow reading, volume total, energy total, power or temperature screens are displayed.
- The instrument responds to the “read holding registers” request (CMD 03).
- If the flow reading is invalid then the flow value will be zero.
- If a U1000MkII-HM temperature sensor goes out of range then the value will go to -11°C (12.2°F).

The above faults will set the relevant status bit (see page 48).

On a unit set to Imperial the temperature is in °F, Power is in BTU/s and flow in US Gallons.

The U1000 complies with the Modbus specification document:

http://www.modbus.org/docs/Modbus_Application_Protocol_V1_1b.pdf

The following registers are available.

Register Offset	Type	Typical Contents	Meaning	Notes
n/a	Byte	0x01	Instrument Address	
n/a	Byte	0x03	Instrument Command	
n/a	Byte	0x40	Number of bytes to read	
0	Int-16	0x00 0xac	Device ID	0xAC U1000MkII-FM/HM
1	Int-16	0x00 0x00	Status	0x0000 OK Not[0x0000] Fault
2	Int-16	0x00 0x04	System Type U1000MkII-HM only	0x04 Heating system 0x0C Chiller system
3	Int-16	0x00 0x01	Serial Identifier	
4	Int-16	0x23 0x45		
5	Int-16	0x60 0x00		
6	IEEE754 float	0x40 0x1f		
7		0x67 0xd3		
8	IEEE754 float	0x41 0x8c	Measured Velocity	Units in m/s
9		0xd8 0xb0		
10	IEEE754 float	0x42 0x1c	Measured Flow	Units in m ³ /hr for Metric Units in US Gal/m for Imperial
11		0x2e 0x34		
12		0x44 0x93		
13	IEEE754 float	0xc6 0xe8	Calculated Power (U1000MkII-HM only)	Units in kW for Metric Units in BTU/s for Imperial
			Calculated Energy (U1000MkII-HM only)	Units in kWh for Metric Units in BTU for Imperial

(continued)

Register Offset	Type	Typical Contents	Meaning	Notes
14	IEEE754 float	0x41	Measured Temperature (Hot) (U1000MkII-HM only)	Units in Degrees Celsius for Metric Units in Degrees Fahrenheit for Imperial
15		0x98		
		0x00		
		0x00		
16	IEEE754 float	0x41	Measured Temperature (Cold) (U1000MkII-HM only)	Units in Degrees Celsius for Metric Units in Degrees Fahrenheit for Imperial
		0x88		
17		0x00		
		0x00		
18	IEEE754 float	0x40	Measured Temperature (Difference) (U1000MkII-HM only)	Units in Degrees Celsius for Metric Units in Degrees Fahrenheit for Imperial
		0x00		
19		0x00		
		0x00		
20	IEEE754 float	0x60	Measured Volume Total	Units in m ³ for Metric Units in US Gal for Imperial
		0xef		
21		0x3c		
		0x1c		
22	Int-16	0x00	Instrument Units	0x00 Metric 0x01 Imperial
		0x00		
23	Int-16	0x00	Instrument Gain	Gain in dB
		0x01		
24	Int-16	0x00	Instrument SNR	SNR in dB
		0x0a		
25	Int-16	0x00	Instrument Signal	Signal in %
		0x62		
26	IEEE754 float	0x42	Measured Delta-Time Difference	Diagnostic Data Units in nanoseconds
		0xc9		
27		0xff		
		0x7d		
28	IEEE754 float	0x42	Instrument ETA	Diagnostic Data Units in nanoseconds
		0xa8		
29		0x8b		
		0xf5		
30	IEEE754 float	0x42	Instrument ATA	Diagnostic Data Units in nanoseconds
		0xc8		
31		0x00		
		0x00		
n/a	Int-16	0xed	CRC-16	
		0x98		

4.4 M-Bus (if fitted)

After power-up, the unit defaults to the baud rate and primary address set in the M-Bus Menu (see page 25). Both the baud rate and primary address may be changed later over the M-Bus network. The secondary address is the unit serial number padded with two zeros.

Characters are configured as 8 data bits, 1 parity even bit and 1 stop bit, and the following bit rates are supported: 300, 2400 and 9600 baud.

The U1000 MKII will only respond to M-Bus requests while operational, while the flow reading, volume total, energy total, power or temperature screens are displayed.

The M-Bus module supports the following functions:

- Acknowledge Function
- Slave Select Function
- Data Transfer Functions
- Switch Baud Rate Function
- Change Primary Address Function

4.4.1 Acknowledge Function

COMMAND:	ACK		
DESCRIPTION:	Response from the slave denoting that a message was received from the master.		
DIRECTION:	SLAVE TO MASTER		
FRAME TYPE:	ACK FRAME		
NAME			
CODE			
ACKNOWLEDGE	0xE5		

4.4.2 Select Slave Function

COMMAND:	SEND_NKE		
DESCRIPTION:	Initialise / Reset slave device for communications.		
DIRECTION:	MASTER TO SLAVE		
FRAME TYPE:	SHORT / LONG FRAME		
PRIMARY ADDRESSING			
NAME		CODE	
START	0x10	START	0x68
(C - FIELD) INITIALISE SLAVE	0x40	LENGTH	0x0B
(A - FIELD) SLAVE PRIMARY ADDRESS	0xXX	LENGTH	0x0B
CHECKSUM	0xXX	START	0x68
STOP	0x16	(C – FIELD) INITIALISE SLAVE	0x73
		(A – FIELD) USE SECONDARY ADDRESSING	0xFD
		(CI – FIELD) INITIALISE SLAVE	0x52
		M-Bus IIN (BYTE 1)	0xXX
		M-Bus IIN (BYTE 2)	0xXX
		M-Bus IIN (BYTE 3)	0xXX
		M-Bus IIN (BYTE 4)	0xXX
		MANF. ID (BYTE 1)	0xCD
		MANF. ID (BYTE 2)	0x54
		VERSION NUMBER	0x01
		DEVICE TYPE ID	0x04
		CHECKSUM	0xXX
		STOP	0x16

MASTER TO SLAVE: SEND_NKE

SLAVE TO MASTER: ACK

4.4.3 Data Transfer Functions

No	VARIABLE	TYPE	SELECTION BITS
1	FLOW RATE	IEEE754 FLOAT	LITRES / MINUTE
2	ENERGY	IEEE754 FLOAT	kWh
3	POWER	IEEE754 FLOAT	kW
4	TEMPERATURE (COLD)	IEEE754 FLOAT	CELCIUS
5	TEMPERATURE (HOT)	IEEE754 FLOAT	CELCIUS
6	TEMPERATURE (DIFFERENCE)	IEEE754 FLOAT	CELCIUS

4.4.4 REQ_UD2 – REQUEST DATA

COMMAND:	REQ_UD2 – REQUEST DATA		
DESCRIPTION:			
DIRECTION:	MASTER TO SLAVE		
FRAME TYPE:	CONTROL / LONG FRAME		
PRIMARY ADDRESSING		SECONDARY ADDRESSING	
NAME	CODE	NAME	CODE
START	0x68	START	0x68
LENGTH	0x04	LENGTH	0x0C
LENGTH	0x04	LENGTH	0x0C
START	0x68	START	0x68
(C - FIELD) SEND_UD	0x73	(C - FIELD) SEND_UD	0x73
(A - FIELD) SLAVE PRIMARY ADDRESS	0xXX	(A - FIELD) USE SECONDARY ADDRESSING	0xFD
(CI – FIELD) SEND DATA TO SLAVE	0x51	(CI – FIELD) SEND DATA TO SLAVE	0x51
DIF: REQUEST ALL DATA	0x7F	M-Bus IIN (BYTE 1)	0xXX
CHECKSUM	0xXX	M-Bus IIN (BYTE 2)	0xXX
STOP	0x16	M-Bus IIN (BYTE 3)	0xXX
		M-Bus IIN (BYTE 4)	0xXX
		MANF. ID (BYTE 1)	0xCD
		MANF. ID (BYTE 2)	0x54
		VERSION NUMBER	0x01
		DEVICE TYPE ID	0x04
		DIF: REQUEST ALL DATA	0x7F
		CHECKSUM	0xXX
		STOP	0x16

MASTER TO SLAVE: SEND_NKE

SLAVE TO MASTER: ACK

MASTER TO SLAVE: REQ_UD2 – REQUEST DATA

SLAVE TO MASTER: RSP_UD2 – RETURN DATA

4.4.5 RSP_UD2 – RETURN DATA

COMMAND:	RSP_UD2 – RETURN DATA			
DESCRIPTION:				
DIRECTION:	SLAVE TO MASTER			
FRAME TYPE:	LONG FRAME			
NAME	DESCRIPTION	SIZE	CODE	
START		1	0x68	
LENGTH		1	0xXX	
LENGTH		1	0xXX	
START		1	0x68	
(C - FIELD)	RSP_UD	1	0x08	
(A - FIELD)	SLAVE PRIMARY ADDRESS	1	0xXX	
(CI – FIELD)	RETURN DATA FROM SLAVE	1	0x72	
M-Bus IIN (BYTE 1)	12-BYTE FRAME HEADER	1	0xXX	
M-Bus IIN (BYTE 2)		1	0xXX	
M-Bus IIN (BYTE 3)		1	0xXX	
M-Bus IIN (BYTE 4)		1	0xXX	
MANF. ID (BYTE 1)		1	0xCD	
MANF. ID (BYTE 2)		1	0x54	
VERSION NUMBER		1	0x01	
DEVICE TYPE ID		1	0x04	
ACCESS NUMBER		1	0xXX	
M-Bus INTERFACE STATUS		1	0xXX	
SIGNATURE 1		1	0x00	
SIGNATURE 2		1	0x00	
DATA BLOCK 1				
DATA BLOCK 2				
DATA BLOCK 3				
DATA BLOCK 4				
DATA BLOCK 5				
DATA BLOCK 6				
DIF	0x0F IDENTIFIES LAST BLOCK	1	0x0F	
CHECKSUM		1	0xXX	
STOP		1	0x16	

MASTER TO SLAVE: SEND_NKE

SLAVE TO MASTER: ACK

MASTER TO SLAVE: REQ_UD2 – REQUEST DATA

SLAVE TO MASTER: RSP_UD2 – RETURN DATA

4.4.6 Switch Baud Rate Function

SEND_UD – SET BAUD RATE 300

COMMAND:		SEND_UD – SET BAUD RATE 300	
DESCRIPTION:		Sets the slave data rate to 300 baud. The slave responds to the request with ACK at the current baud and then modifies its baud setting. If the slave does not receive a message from the master at the new rate within 2 minutes, the slave defaults to a setting of 300 baud.	
DIRECTION:		MASTER TO SLAVE	
FRAME TYPE:		CONTROL / LONG FRAME	
PRIMARY ADDRESSING		SECONDARY ADDRESSING	
NAME	CODE	NAME	CODE
START	0x68	START	0x68
LENGTH	0x03	LENGTH	0x0B
LENGTH	0x03	LENGTH	0x0B
START	0x68	START	0x68
(C - FIELD) SEND_UD	0x73	(C - FIELD) SEND_UD	0x73
(A - FIELD) SLAVE PRIMARY ADDRESS	0xXX	(A - FIELD) USE SECONDARY ADDRESSING	0xFD
(CI – FIELD) SET BAUD RATE 300	0xB8	(CI – FIELD) SET BAUD RATE 300	0xB8
CHECKSUM	0xXX	M-Bus IIN (BYTE 1)	0xXX
STOP	0x16	M-Bus IIN (BYTE 2)	0xXX
		M-Bus IIN (BYTE 3)	0xXX
		M-Bus IIN (BYTE 4)	0xXX
		MANF. ID (BYTE 1)	0xCD
		MANF. ID (BYTE 2)	0x54
		VERSION NUMBER	0x01
		DEVICE TYPE ID	0x04
		CHECKSUM	0xXX
		STOP	0x16

MASTER TO SLAVE: SEND_NKE

SLAVE TO MASTER: ACK

MASTER TO SLAVE: SEND_UD – SET 300 BAUD

SLAVE TO MASTER: ACK

SEND_UD – SET BAUD RATE 2400

COMMAND:	SEND_UD – SET BAUD RATE 2400		
DESCRIPTION:	Sets the slave data rate to 2400 baud. The slave responds to the request with ACK at the current baud and then modifies its baud setting. If the slave does not receive a message from the master at the new rate within 2 minutes, the slave defaults to a setting of 300 baud.		
DIRECTION:	MASTER TO SLAVE		
FRAME TYPE:	CONTROL / LONG FRAME		
PRIMARY ADDRESSING			
NAME		CODE	
START	0x68	START	0x68
LENGTH	0x03	LENGTH	0x0B
LENGTH	0x03	LENGTH	0x0B
START	0x68	START	0x68
(C - FIELD) SEND_UD	0x73	(C - FIELD) SEND_UD	0x73
(A - FIELD) SLAVE PRIMARY ADDRESS	0xXX	(A - FIELD) USE SECONDARY ADDRESSING	0xFD
(CI – FIELD) SET BAUD RATE 2400	0xBB	(CI – FIELD) SET BAUD RATE 2400	0xBB
CHECKSUM	0xXX	M-Bus IIN (BYTE 1)	0xXX
STOP	0x16	M-Bus IIN (BYTE 2)	0xXX
		M-Bus IIN (BYTE 3)	0xXX
		M-Bus IIN (BYTE 4)	0xXX
		MANF. ID (BYTE 1)	0xCD
		MANF. ID (BYTE 2)	0x54
		VERSION NUMBER	0x01
		DEVICE TYPE ID	0x04
		CHECKSUM	0xXX
		STOP	0x16

MASTER TO SLAVE: SEND_NKE

SLAVE TO MASTER: ACK

MASTER TO SLAVE: SEND_UD – SET 2400 BAUD

SLAVE TO MASTER: ACK

SEND_UD – SET BAUD RATE 9600

COMMAND:	SEND_UD – SET BAUD RATE 9600		
DESCRIPTION:	Sets the slave data rate to 9600 baud. The slave responds to the request with ACK at the current baud and then modifies its baud setting. If the slave does not receive a message from the master at the new rate within 2 minutes, the slave defaults to a setting of 300 baud.		
DIRECTION:	MASTER TO SLAVE		
FRAME TYPE:	CONTROL / LONG FRAME		
PRIMARY ADDRESSING			
NAME	CODE	SECONDARY ADDRESSING	
NAME	CODE	NAME	CODE
START	0x68	START	0x68
LENGTH	0x03	LENGTH	0x0B
LENGTH	0x03	LENGTH	0x0B
START	0x68	START	0x68
(C - FIELD) SEND_UD	0x73	(C - FIELD) SEND_UD	0x73
(A - FIELD) SLAVE PRIMARY ADDRESS	0xXX	(A - FIELD) USE SECONDARY ADDRESSING	0xFD
(CI – FIELD) SET BAUD RATE 9600	0xBD	(CI – FIELD) SET BAUD RATE 9600	0xBD
CHECKSUM	0xXX	M-Bus IIN (BYTE 1)	0xXX
STOP	0x16	M-Bus IIN (BYTE 2)	0xXX
		M-Bus IIN (BYTE 3)	0xXX
		M-Bus IIN (BYTE 4)	0xXX
		MANF. ID (BYTE 1)	0xCD
		MANF. ID (BYTE 2)	0x54
		VERSION NUMBER	0x01
		DEVICE TYPE ID	0x04
		CHECKSUM	0xXX
		STOP	0x16

MASTER TO SLAVE: SEND_NKE

SLAVE TO MASTER: ACK

MASTER TO SLAVE: SEND_UD – SET 9600 BAUD

SLAVE TO MASTER: ACK

4.4.7 Change Primary Address Function

COMMAND:	SEND_UD – SET PRIMARY ADDRESS		
DESCRIPTION:	The primary address of the slave is set to a default value at power up. The master uses this command to assign a new unique primary address to the slave if required.		
DIRECTION:	MASTER TO SLAVE		
FRAME TYPE:	LONG FRAME		
PRIMARY ADDRESSING		SECONDARY ADDRESSING	
NAME	CODE	NAME	CODE
START	0x68	START	0x68
LENGTH	0x06	LENGTH	0x0E
LENGTH	0x06	LENGTH	0x0E
START	0x68	START	0x68
(C - FIELD) SEND_UD	0x73	(C - FIELD) SEND_UD	0x73
(A - FIELD) SLAVE PRIMARY ADDRESS	0xXX	(A - FIELD) USE SECONDARY ADDRESSING	0xFD
(CI – FIELD)	0x51	(CI – FIELD)	0x51
DIF: 8 BIT INTEGER	0x01	M-Bus IIN (BYTE 1)	0xXX
VIF: SET PRIMARY ADDRESS	0x7A	M-Bus IIN (BYTE 2)	0xXX
NEW PRIMARY ADDRESS VALUE	0xXX	M-Bus IIN (BYTE 3)	0xXX
CHECKSUM	0xXX	M-Bus IIN (BYTE 4)	0xXX
STOP	0x16	MANF. ID (BYTE 1)	0xCD
		MANF. ID (BYTE 2)	0x54
		VERSION NUMBER	0x01
		DEVICE TYPE ID	0x04
		DIF: 8 BIT INTEGER	0x01
		VIF: SET PRIMARY ADDRESS	0x7A
		NEW PRIMARY ADDRESS VALUE	0xXX
		CHECKSUM	0xXX
		STOP	0x16

MASTER TO SLAVE: SEND_NKE

SLAVE TO MASTER: ACK

MASTER TO SLAVE: SEND_UD – SET PRIMARY ADDRESS

SLAVE TO MASTER: ACK

5 RELOCATING THE UNIT

If it is necessary to relocate the unit use the following procedure:

1. Disconnect the temperature sensors (U1000MkII-HM only) and MODBUS cable (if used).
2. Unfasten hose clips and remove the complete unit from the pipe.
3. Undo the screw at the end of the Sensor Assembly and gently lift the same end of the Electronics Module as shown below.
4. The opposite end of the Electronics Module can now be released from the Sensor Assembly.



Figure 24 Separating Sensor Assembly and Electronics Module

5. Disconnect the two wires connecting the Sensor Assembly and Electronics Module.
6. Remove the original gel pads from the two sensors.
7. Push the sensor blocks into the Sensor Assembly so that the washers and locking screws can be refitted.
8. Place replacement gel pads on the base of the sensors.
9. Follow the procedure for re-installing the unit on the pipe (see page 16).

6 APPENDIX

6.1 Specification

General	
Measuring Technique	Transit time
Measurement channels	1
Timing Resolution	±50ps
Turn down ratio	200:1
Flow velocity range	0.1 to 10m/s
Applicable Fluid types	Clean water with < 3% by volume of particulate content, or up to 30% ethylene glycol.
Accuracy	±3% of flow reading for velocity rate >0.3m/s
Repeatability	±0.15% of measured value
Pipe Ranges	25-115mmOD and 125-180mm OD Note: Pipe size is dependent on pipe material and internal diameter.
Selectable units for metric (mm)	Velocity: m/s Flow Rate: l/s, l/min, m ³ /min, m ³ /hr Volume: litres, m ³
Selectable units for Imperial (inches)	Velocity: ft/s Flow rate: gal/min, gal/hr, USgal/min, USgal/hr Volume: gals, USgals
Totaliser	14 digits with roll over to zero
Languages supported	English only
Power input	12 – 24V DC or 24V AC
Power consumption	7W (DC) or 7VA (AC) maximum
Cable	5m screened 6 core
Pulse Output	
Output	Opto-isolated MOSFET volt free contact (NO/NC).
Isolation	1MΩ @ 100V
Pulse width	Default value 50ms; programmable range 3 – 99ms
Pulse repetition rate	Up to 166 pulses/sec (depending on pulse width)
Frequency mode	200 Hz maximum (Range 1-200)
Maximum load voltage/current	24V DC or 24V AC / 500mA
Current Output <i>U1000MkII-FM only (if fitted)</i>	
Output	4 – 20mA
Resolution	0.1% of full scale
Maximum load	620Ω
Isolation	1MΩ @ 100V
Alarm current	3.5mA

continued on next page

continued from previous page

Modbus (if fitted)	
Format	RTU
Baud rate	1200, 2400, 4800, 9600, 19200, 38400
Data-Parity-StopBits	8-None-2, 8-None-1, 8-Odd-2, 8-Even-1
Standards	PI-MBUS-300 Rev. J
Physical connection	RS485
M-Bus (if fitted)	
Baud rates	300, 2400, & 9600
Data-Parity-StopBits	8-Even-1
Standards	EN13757 / EN1434
Temperature sensors	<i>U1000MkII-HM only</i>
Type	PT100 Class B 4 wire
Range	2 to 85°C (36 to 185°F)
Resolution	0.1°C / 1°F
Sensor Accuracy	±0.725°C (±1.305°F)
Enclosure	
Material	Plastic Polycarbonate
Fixing	Pipe mountable
Degree of Protection	IP54 (Not verified by UL)
Flammability Rating	UL94 V-2/HB
Dimensions	250mm x 48mm x 90mm (electronics module + sensor assembly)
Weight	0.5kg
Environmental	
Maximum Pipe temperature	0°C to 85°C
Operating temperature (Electronics)	0°C to 50°C
Storage temperature	-10°C to 60°C
Humidity	90% RH at 50°C Max
Maximum altitude	4,000 metres
Indoors/outdoors	Indoors
Wet locations	A location in which water or other liquid can drip, splash, or flow on or against electrical equipment.
Pollution degree	3: Conductive pollution or dry nonconductive pollution that becomes conductive due to condensation.
Display	
LCD	2 line x 16 characters
Viewing angle	Min 30°
Active area	58mm (W) x 11mm(H)
Keypad	
Format	4 key tactile feedback membrane keypad



! Servicing or repairs to the unit can only be carried out by the manufacturer.

6.2 Default values

The settings will be configured at the factory for metric units. The following table lists the metric and imperial default values.

Parameter	Default Value	
	Metric	Imperial
Dimensions	mm	inches
Flow Units	l/min	USgal/min
Pipe size (ID)	1" to 4" pipes: 50 mm 4" to 6" pipes: 127 mm	1" to 4": 1.969 in 4" to 6": 5.000 in
Pulse Output	Off	Off
Energy per Pulse <i>(U1000MkII-HM only)</i>	1kW	1kBTU
Volume per Pulse	10 litres	2.642 US gallons
Pulse Width	50 ms	50 ms
Damping	20 seconds	20 seconds
Calibration Factor	1.000	1.000
Zero Cut-off	0.02 m/s	0.07 ft/s
Zero Offset	0.000 m/s	0.000 ft/s

6.3 Limitations with Water-Glycol Mixtures

There is little available data on the specific heat capacity (K factor) for water glycol mixes and there is no practical method of determining the percentage of glycol in a system or the type of glycol in use. The flow calculations are based on a Water/Ethylene glycol mix of 30%.

In practical terms the results should not be considered more than an approximation as:

The fluid speed of sound can vary between 1480ms and 1578ms

No temperature compensation curve is available for water/glycol mixes,

The percentage of Glycol can vary the specific heat capacity from 1.00 to 1.6 J/M3 * K

The type of glycol added can change the specific heat capacity and fluid speed of sound considerably.

The Factory enabled user set-up of the application relies on the installer to set the correct operating parameters, a considerable variation in results can be obtained from incorrectly set-up units.

6.4 Positioning

For accurate measurements, the U1000MKII-FM/U1000MKII-HM must be installed at a position where the fluid flows uniformly. Flow profile distortions can result from upstream disturbance such as bends, tees, valves, pumps and other similar obstructions. To ensure a uniform flow profile, the unit must be mounted away from any cause of flow disturbance.

As a guide, we suggest this is best achieved by ensuring there is a straight length of pipe upstream of the transducers of at least 10 times the pipe diameter, and 5 times the pipe diameter on the downstream side, as shown in Figure 3, but this may vary. Flow Measurements can be made on

shorter lengths of straight pipe, but when the transducers are mounted this close to any obstruction the resulting errors can be unpredictable.

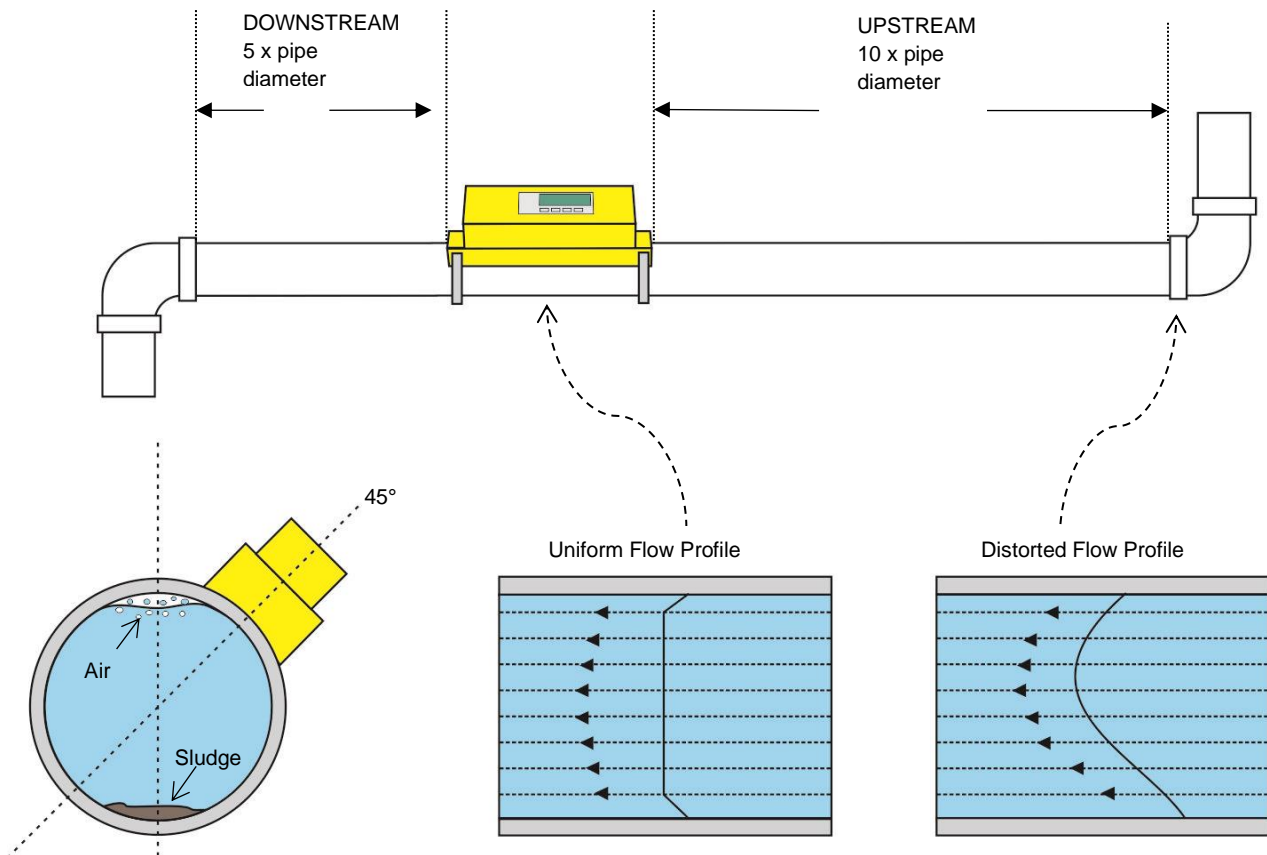

Figure 25 Location of unit

To obtain the most accurate results, the condition of both the liquid and the pipe must be suitable to allow ultrasound transmission along the predetermined path.

In many applications, an even flow velocity profile over a full 360° is unattainable due, for example, to the presence of air turbulence at the top of the flow and also possibly sludge at the bottom of the pipe. Experience has shown that the most consistently accurate results are achieved when the sensors are mounted at 45° with respect to the top of the pipe. In chiller applications, the U1000MKII sensor/electronics must be mounted at 45° with respect to the top of the pipe to prevent condensation entering the electronics unit.

IMPORTANT: DO NOT EXPECT TO OBTAIN ACCURATE RESULTS IF THE UNIT IS POSITIONED CLOSE TO ANY OBSTRUCTION THAT DISTORTS THE UNIFORMITY OF THE FLOW PROFILE. MICRONICS LTD ACCEPTS NO RESPONSIBILITY OR LIABILITY IF PRODUCT HAS NOT BEEN INSTALLED IN ACCORDANCE WITH THESE INSTRUCTIONS.

6.5 Error and Warning Messages

6.5.1 Error Messages

Error Messages are displayed as a number in the diagnostics menu. Contact Micronics if other messages appear.

Error Meaning	Status Byte								Value
	Bit#7	Bit#6	Bit#5	Bit#4	Bit#3	Bit#2	Bit#1	Bit#0	
RTD I2C failed <i>(U1000MkII-HM only)</i>								1	1
RTD Thot failed <i>(U1000MkII-HM only)</i>							1		2
RTD Tcold failed <i>(U1000MkII-HM only)</i>						1			4
TOFM signal lost					1				8
TOFM board failed				1					16
TOFM window failed			1						32
TOFM sensor type failed		1							64
TOFM I2C failed	1								128

6.5.2 Example Error Messages

Error Message	Error Meaning
None or 0	None
2	Hot sensor error <i>(U1000MkII-HM only)</i>
4	Cold sensor error <i>(U1000MkII-HM only)</i>
6	Hot and Cold sensor error <i>(U1000MkII-HM only)</i>
8	No flow signal
10	Hot error and no flow signal <i>(U1000MkII-HM only)</i>
12	Cold error and no flow signal <i>(U1000MkII-HM only)</i>
14	Hot and Cold error and no flow signal <i>(U1000MkII-HM only)</i>

6.5.3 Modbus Error Messages (if Modbus fitted)

Test case	Transmitter							
	Address	Command	Start Register		Length (no of registers)		CRC-16	
	[1 byte]	[1 byte]	[2 bytes]		[2 bytes]		[2 bytes]	
No error	0x01	0x03	0x00	0x00	0x00	0x20	0x44	0x12
Incorrect function request	0x01	0x0C	0x00	0x00	0x00	0x20	0x10	0x13
incorrect register start	0x01	0x03	0x00	0xEF	0x00	0x20	0x75	0xE7
Incorrect register length	0x01	0x03	0x00	0x12	0xFF	0x02	0x25	0xFE
slave is busy	0x01	0x03	0x00	0x00	0x00	0x20	0x44	0x12
incorrect CRC-16	0x01	0x03	0x00	0x20	0x00	0x20	0x44	0xFF

Receiver					Comments
Address	Command	Error code	CRC-16		
[1 byte]	[1 byte]	[1 byte]	[2 bytes]		
0x01	0x03	None	n/a	n/a	Example of a good message
0x01	0x8C	0x01	0x85	0x00	ILLEGAL FUNCTION - the only acceptable command is 0x03
0x01	0x83	0x02	0xC0	0xF1	ILLEGAL DATA ADDRESS - incorrect register start
0x01	0x83	0x03	0x01	0x31	ILLEGAL DATA VALUE - incorrect register length
0x01	0x83	0x06	0xC1	0x32	SLAVE DEVICE BUSY – U1000 is busy processing and is unable to respond
0x01	0x83	0x07	0x00	0xF2	CRC is incorrect

6.5.4 Flow Errors

A signal strength of less than 40% indicates poor set up of the instrument, and the installation should be checked or possibly moved to a different site.

6.5.5 Flow Warnings

A signal strength of less than 40% indicates poor set up of the instrument, and the installation should be checked or possibly moved to a different site. A negative flow is indicated by an "!" being displayed on the top line instead of a "*" .

6.5.6 Data Entry Errors

These generally advise you that the data entered is not within the specified range:

**Range 20.0 – 165.1
0.000 mm**

Displayed when an invalid Pipe ID is entered, prompting the user to enter a value between 20 and 165mm depending on the product purchased.

**Calibrate Error
Press Enter**

An attempt has been made to zero the offset between the temperature sensors, and the difference in temperature is too large. Ensure the temperature sensors are correctly plugged in and are both at the same temperature.

**Range 1 - 200
200**

When programming a Frequency Pulse output the frequency is limited to the range 1 to 200 Hz.

**Range 3 - 99
0000.0**

When programming a Volume Pulse output the pulse width is limited to the range 3 to 99ms.

**Range 0.00 – 0.500
0000.0**

When programming the Zero Cut-off this is limited to the range 0.000 to 0.500.

NOTE: THIS MUST BE SET TO ZERO BEFORE PERFORMING A ZERO OFFSET.

**Range 0.500 – 1.500
0000.0**

When programming the Calibration Factor this is limited to the range 0.5 to 1.5.

7 DECLARATION OF CONFORMITY



MICRONICS EU Declaration of Conformity

Micronics Ltd

Knaves Beech Business Centre
Davies Way, Loudwater,
High Wycombe, Bucks.
HP10 9QR

The Products Covered by this Declaration Ultrasonic flow meter U1000, U1000-HM and U1000MKII

This product is manufactured in accordance with the following Directives and Standards.

Directive 2014/30/EU of the European Parliament and of the Council of 26 February 2014 on the approximation of the laws of the Member States relating to electromagnetic compatibility

Directive 2014/35/EU of the European Parliament and of the Council of 26 February 2014 on the harmonisation of the laws of Member States relating to electrical equipment designed for use within certain voltage limits

The Basis on which Conformity is being Declared

The manufacturer hereby declares under his sole responsibility that the products identified above comply with the protection requirements of the EMC directive and with the principal elements of the safety objectives of the Low Voltage Equipment directive, and that the following standards have been applied:

BS EN 61010-1:2010 Safety requirement for electrical equipment for measurement control and laboratory use. Part 1 General requirements

BS EN61326-1:2013 Electrical equipment for measurement control and laboratory use EMC requirements. Part 1: General requirements

BS EN61326-2-3:2013 Electrical equipment for measurement control and laboratory use EMC requirements. Part 2-3: Particular requirements – Test configuration and performance criteria for transducers with integrated or remote signal conditioning.

This declaration of conformity is issued under the sole responsibility of the manufacturer.

Signed for and on behalf of : Micronics Ltd.

Signature: _____

Printed Name: Michael Farnon

Title: Managing Director

Date: April 2018 **Location:** Loudwater

Attention!

The attention of the specifier, purchaser, installer, or user is drawn to special measures and limitations to use which must be observed when these products are taken into service to maintain compliance with the above directives.

Details of these special measures and limitations to use are available on request, and are also contained in the product manuals.

Registered Office: Micronics Limited, Knaves Beech Business Centre, Davies Way, Loudwater, Buckinghamshire, HP10 9QR

Web site: www.micronicsflowmeters.com Tel: +44 (1628) 810456

Directors: E.J. Farnon, E. Farnon, M.A. Farnon, D.B. Leigh

Registration No. 1289680 V.A.T. Registration No. 303 6190 91

