

Data Sheet

RHE 26

Rack/Panel/DIN Rail Mount Multifunction
Mass Flow Transmitter



Supplied by

247able.com

Call us on +44 (0)118 916 9420 | Email info@247able.com



RHE 26

Rack/Panel/DIN Rail Mount Multifunction Mass Flow Transmitter

General process flow measurement / Feed stocks and transfers /
OEM applications





Features

- Rack/Panel/Rail Mounting
- Operate with RHM sensor in hazardous area
- Selectable Units for Mass, Volume, Density and Temperature
- Positive, negative and net totalizers for both volume and mass flow
- Two configurable pulse/frequency/status outputs
- Analog output configurable for Mass, Volume, Density or Temperature
- Digital input configurable for zeroing, measurement hold and totalizer operations
- Connectivity to control systems through Modbus RTU
- Simple user interface – Backlit Color LCD display and 3 operator buttons with intuitive menu design
- USB connection for quick service & settings
- Built-in Assurance View® Advanced Diagnostic Set – simple publication of measurement status with Assurance Factor® and/or color changing display
- Password Protected Setup
- Upload and download of configuration files
- Power consumption less than 5W
- Optional lockable front cover

General Specification Overview

Enclosure Material	IEC61554 panel mount housing, PPE/PS-GF20. Lockable front cover and DIN rail mount options available; IP20 (front IP54 with optional lockable cover)
Ambient Temperature	-20°C to +60°C / -4°F to +140°F
Dimensions	Please refer to RHE26 Dimensions page
Display	Large high contrast backlit LCD 128 x 24. Screen changes color to indicate warning or error
Weight	0.45 kg / 1 lb
Operation	3 x front panel operator buttons for all menu navigation and settings
Sensor Connection	Pluggable cage clamp terminal strip. Cable available in lengths up to 100 m / 328 ft for connection to remote sensor
Analog Outputs	1 x 4-20mA output, active or passive
Pulse/Freq/Status Outputs	2 x configurable pulse / frequency / status (IEC 60946), max 10 kHz
Digital Inputs	1 configurable control input (IEC60946).
Digital Data Communications	Modbus RTU (RS485), Connection to PC (USB) with Rheonik RHECom software
Power Supply	12-24 VDC +/- 10%, 4W
Hazardous Area Approvals	ATEX / IECEx for RHE in ordinary locations (code AS), RHM in all zones cCSAus for RHE in ordinary locations (code CS), RHM in all divisions

Hazardous Area Installation Overview

Zone 0,1 / Class I, Div. 1



Zone 2 / Class I, Div. 2



Ordinary Locations



Sensor and transmitter must have matching approvals

Software Function Packages and Features

Standard Operation Package (Part Number Code S0)

The RHE26 Standard Operation Package provides the following measurement and function features:

Direct Mass Flow Measurement

Mass flow is calculated using the Coriolis principle to provide a high accuracy Mass Flow measurement of the fluid flowing through an Omega Tube Coriolis Meter.

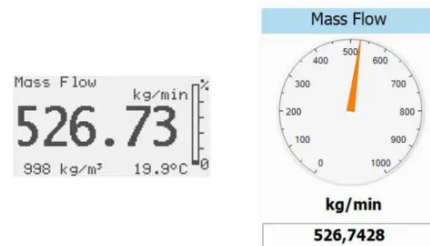

Temperature Measurement

Each Omega Tube Coriolis Sensor provides a temperature measurement from built in sensors.

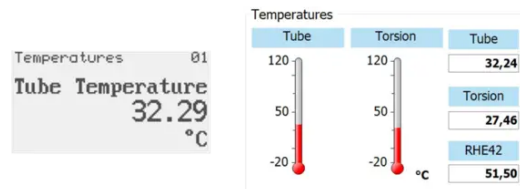

Fixed and Calculated Density Function

The Fixed Density function allows to enter a fixed density value for volumetric flow calculations.

The Calculated Density function allows density to be generated based upon process temperature. A base/reference density at a known temperature is entered for the fluid being measured along with a coefficient describing the change in density per temperature unit. The firmware in the transmitter calculates flowing density based upon this information to use for volumetric flow calculations.

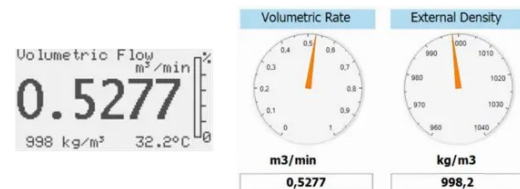

Calculated Actual Volume Measurement for Liquids and Gas

Volume measurement is calculated by dividing direct mass flow measurement by the Fixed Density.

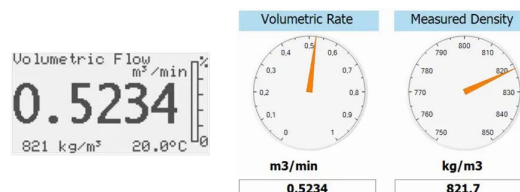

Standardized/Normalized Volume Measurement for Gas

This function calculates the volume of gas passing through the meter at standard conditions. The density of the gas at standard conditions is entered into the transmitter and the volume is calculated using this in conjunction with the flowing mass.

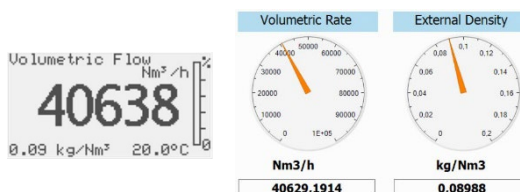

Standard Package (Part Number Code S0) continue

Password Protection

All setup and calibration parameters within the meter are protected with passwords to prevent unintentional or unauthorized change once installed.



Batch Controller

The transmitter is equipped with an onboard batch controller that, in conjunction with external pumps and/or valves allows the precise delivery of a preset mass or volume of process fluid on demand. Operated from the instrument front panel, remotely via operator switches or through digital communication from a connected supervisory control system, the controller is configured to utilize either a one stage or a two stage delivery strategy in ensuring the right amount of fluid is batched through the meter. The electronics self-learns, adjusting shut off times as more and more batches are delivered to further refine the amount of delivery, saving material costs and improving quality.

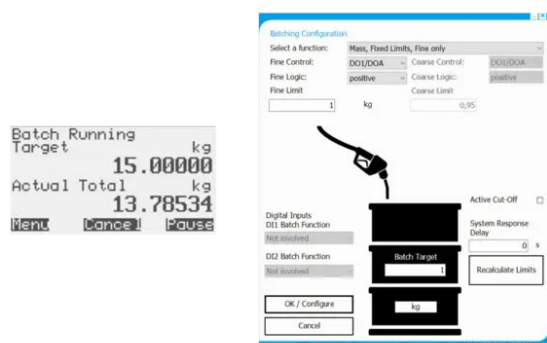

Assurance View® Diagnostics

Inbuilt self-monitoring functions are available that can be used to determine the reliability of the flow meter readings at all times. Diagnostics are quickly accessed through dedicated menu displays, RHECom software and the MODBUS interface.



Density Operation Package (Part Number Code D0)

The RHE26 Density Operation Package includes all features from the Standard Operation Package plus the following measurement and function features:

Direct Density and Volume Measurement

The flowing density of the fluid in an Omega Tube Coriolis Sensor is determined from the measured resonant frequency of the sensor and used to calculate instantaneous volumetric flowrate.



Density Package (Part Number Code DO) continue

Brix/Baume Units

The unit can be configured to read out in °Brix or Baume. °Brix or Baume are used extensively in the sugar and beverage industries.

°Brix

°Bé

Partially Filled Pipe Management – Lite Version

Often referred to as multiphase flow, the flow regime in a partially filled pipe can cause large measurement errors and even create a measurement fault condition in a Coriolis Flow Meter. When PFPM is activated, density measurement is continuously compared to preset limits to determine if the sensor is seeing a liquid/gas mixture running through it. When multiphase flow is detected, it can be signaled, e.g. by a DO, to alert users and allow action to be taken to minimize error. The full version of PFPM is available with the Assurance Diagnostics Package – see the next section for details.

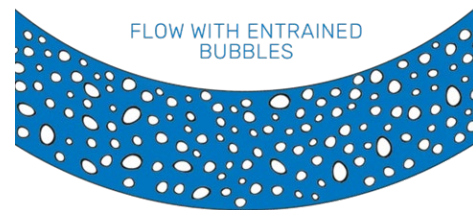

Assurance Factor Package with Assurance Diagnostics Suite (Part Number Code AF)

The RHE26 Assurance Factor Package includes all features from the Density Operation Package plus the following advanced diagnostic functions:

Assurance Factor®

Assurance Factor® is a numeric value generated by an internal algorithm that indicates the overall health of the flow meter and measurement. Assurance Factor® value can be used to trigger changes in screen color when the optional display is fitted to the RHE26 (White – Amber – Blue – Red), providing highly visible wide area condition indication.



WHITE

Normal Operation

No faults present. All parameters within expected limits. Meter fully operational

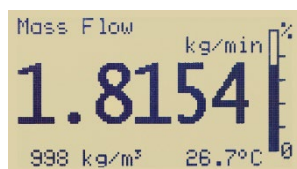

AMBER

Operation Not Optimal

Sensor subject to noise / changing conditions in pipe. Measurement quality may be compromised



BLUE

Operation at Limit

Sensor experiencing disturbance. Measurement quality compromised

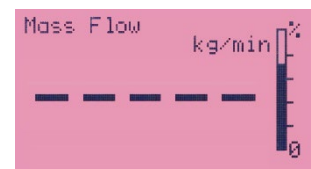

RED

Measurement Failure

Sensor experiencing extreme disturbance / meter in fault. Measurement offline

Program Package Function Summary

Feature	Program Package Code		
	SO	DO	AF
Live Mass Flow Measurement	X	X	X
Live Temperature Measurement	X	X	X
Inferred Density by Reference Density and Temp.	X	X	X
Fixed or Norm Density Value (e.g. kg/Nm ³)	X	X	X
Volumetric Flow from Inferred/ Fixed/Norm Density	X	X	X
Standardized Gas Volume Calculation	X	X	X
Resettable Mass / Volume Totalizers	X	X	X
Non-Resettable Mass / Volume Totalizers	X	X	X
Single and Two Stage Batch Control	X	X	X
Self Learning Batch Control	X	X	X
Assurance View® Diagnostics	X	X	X
Setup/Configuration Password Protection	X	X	X
Live Density Measurement		X	X
Volume using Mass and Measured Density		X	X
Brix / Baume Units		X	X
Assurance Factor® Calculation and Diagnostics			X
PID Controller for Analog Output (e.g. Pump, Valve)			X
Partly Filled Pipe Management			X

RHECom Software

The RHE26 transmitter is a fully featured device with many sophisticated functions and configuration is necessary for proper performance of these functions. RHECom software is available in three versions – Free, Pro and Pro+.

RHEComFree is available for download at no extra cost or on USB flash drive. RHEComFree allows full setup of transmitter parameters and includes a useful datalogging function for monitoring performance of the meter.

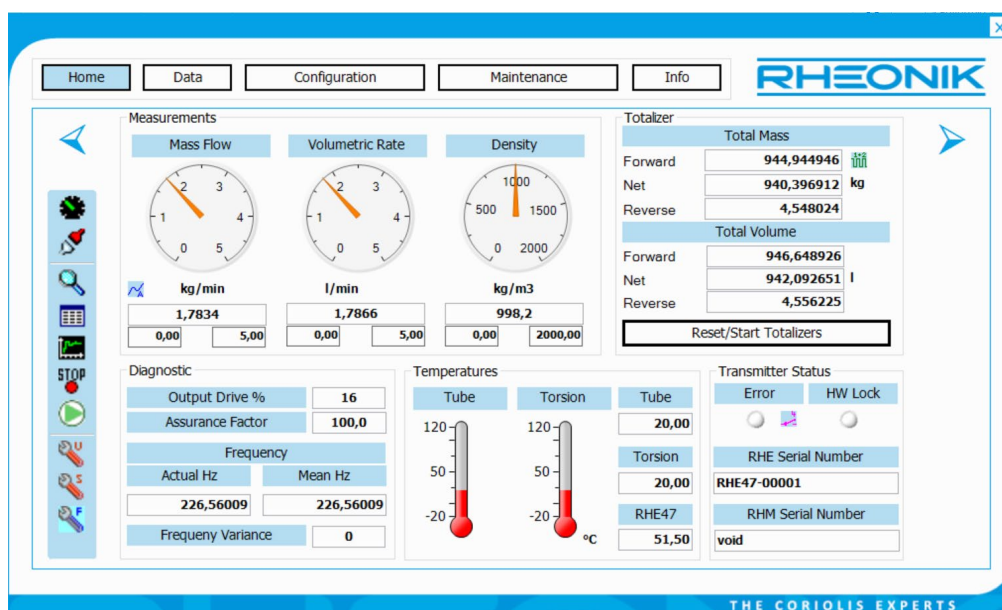

For a small one-time license fee, RHEComPro and RHEComPro+ offer additional insight and setup convenience menus. RHEComPro includes data logging, trending and broad diagnostic capabilities.

RHEComPro+ takes flow meter management one step further with a revolutionary fully functioning simulator application. With the simulator, you can trial run your application from the convenience of your office, adjusting transmitter settings, setting alarms and filters, and creating transmitter configuration files for upload into the actual unit. The simulator is also ideal for training - it exactly mimics the front panel of the instrument display and buttons when clicked and includes controls for adjusting flow, density and temperature readings just like the unit was in line!

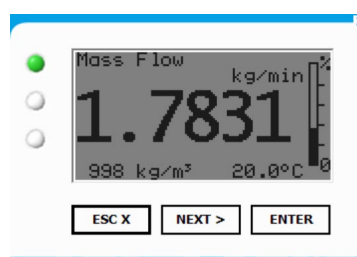
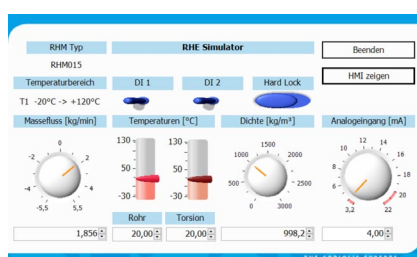

RHECom software is designed to ensure simple and expedient setup of Rheonik transmitter features and functions – a real time saver and a valuable tool.

Mechanical Construction

Type E1

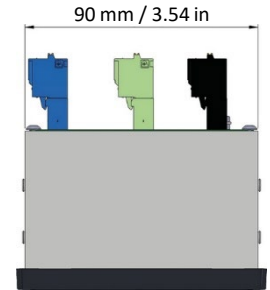
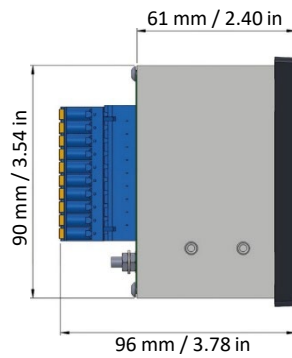

Type E2

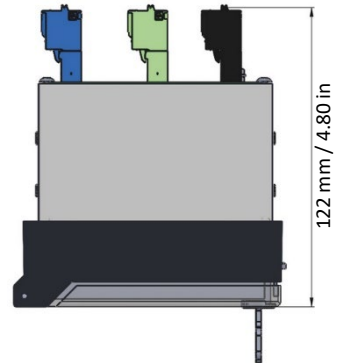
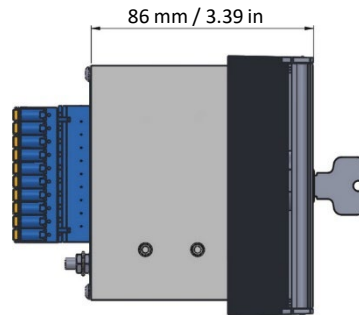
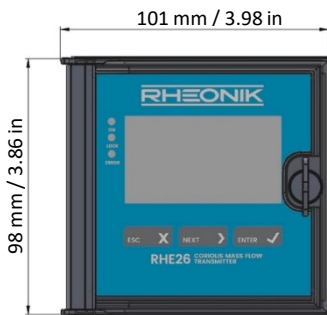

Type H1

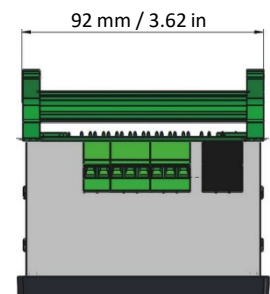
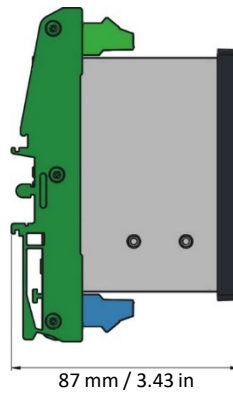

Type H2

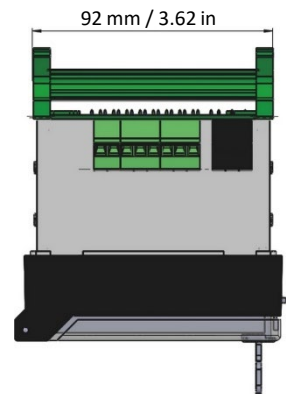
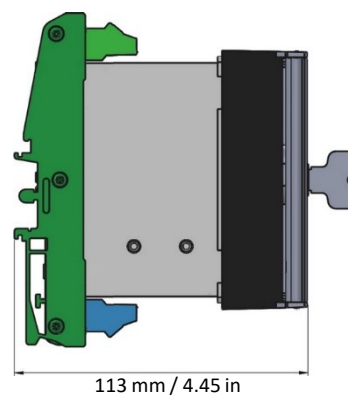

Electrical connection to transmitter compatibility

Electrical connection option selections are compatible with the transmitter range according to the following table. Note that economical blind front versions of some transmitters are available where displays and keypads are not required. The wide range of Rheonik sensors and transmitters provide tremendous options for system designers and end users alike.

	Order Code	JM	SM	TM	J5	C2	PM
	RHE 21	✓	✓	✓	-	-	✓
	RHE 26	✓	✓	✓	-	-	✓
	RHE 27	✓	✓	✓	-	-	✓
	RHE 28	✓	✓	✓	-	-	✓
	RHE 42	✓	✓	✓	-	✓	✓
	RHE 45	-	-	-	✓	-	-
	RHE 46	✓	✓	✓	-	-	✓
	RHE 49	-	-	-	✓	-	-

RHE 26 Part Number Code

Construction Type

- E1 Standard panel mount version (IP20)
- E2 Panel mount version with lockable cover (IP20 / IP54 front)
- H1 DIN rail mount version (IP20)
- H2 DIN rail mount version with lockable cover (IP20)

Supply Voltage

D1 12 to 24 VDC ±10%

Software Function Package

- SO Standard package: mass flow measurement, norm. density/volume
- DO Multifunction package: mass, volume flow and measured density/volume
- AF Multifunction package plus Assurance Factor® diagnostics suite

I/O Configuration

S1 RS485 (Modbus RTU), 1 x 4-20mA, 2 x DO (pulse/freq./status), 1 x DI

Hazardous Area Approval (details see page 13)

- NN Without - RHM and RHE in ordinary locations
- AS ATEX / IEC Ex II (1)G [Ex ia Ga] IIC - RHE in ordinary locations
- CS cCSAus Class I, associated equipment - RHE in ordinary locations

Performance Certification

NN Without

Options for RHE26

- NNN None / all standard
- NNH Hardware lock switch function

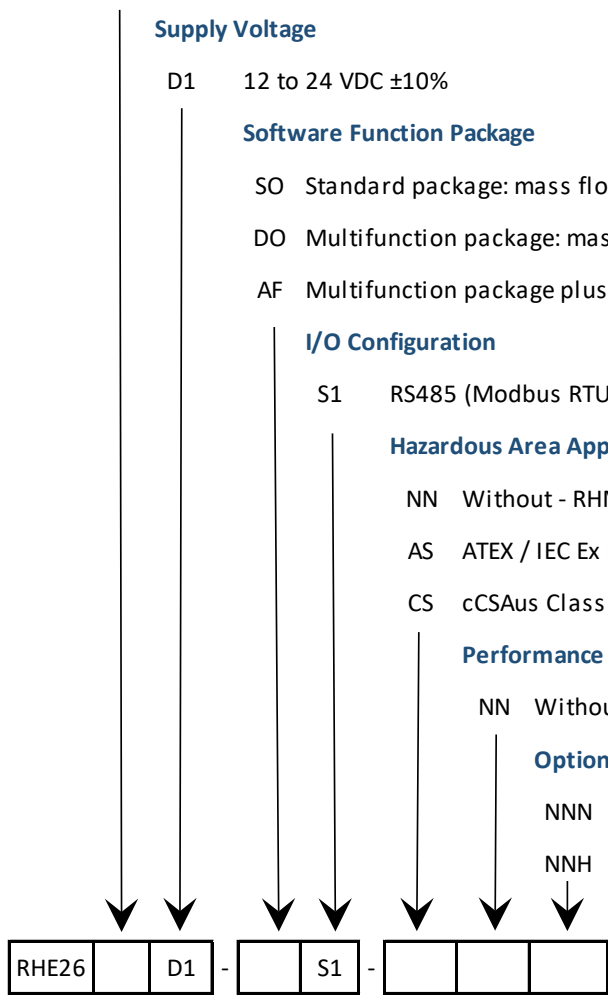

Options and Accessories

Part Number	Description
ORHE-SI	Pre-setting of pulse, analog outputs according to setting instructions.
ARHE26-TN	Terminal Adapter Set for I/Os and Power (spare part for RHE without Ex approval)
ARHE26-TA	Terminal Adapter Set for I/Os and Power (spare part for RHE with Ex approval)
ARHE26-RM	Rack Mount Shade to accommodate RHE26 as rack mount / substitution of RHE07

General Options

Part Number	Description
ARHE-C4	Standard sensor cable, halogen free, -50 to +105°C, 9 wires - not for RHE16
ARHE-C6	Steel armoured sensor cable, halogen free, -50 to +105°C, 9 wires - not for RHE16
ARHE-P3	3m pre-assembled C4 cable (cable ends ready for connection terminals) - not for RHE16
ARHE-P0	10m pre-assembled C4 cable (cable ends ready for connection terminals) - not for RHE16
ARHE-RS	5m PC cable (Mini USB to PC USB) - to connect PC / RHECom PC software for RHE16/2x/4x
ARHE-SO	USB flash drive with PC software RHEComFree, operation manual, calibration certificate(s), csv configuration file(s). One USB drive per order is sufficient. For RHE16/2X/4X
ARHE-PW	DIN Rail Power Supply Module 85 to 250 V to 24 VDC / 15 W (Non Ex) for RHE16/26/27/42
ARHE-MO	Modbus RS485 terminals to PC USB Converter for RHE16/2X/4X
ARHE-PR	PC Software RHEComPRO license key (upgrade for two years are included)
ARHE-PP	PC Software RHEComPRO+ license key (upgrade for two years are included)
ORHE-TP	Plate with TAG number in Stainless Steel (other labelling standard)
ORHE-TP-C	Complete labelling (type information, TAG, Ex label) in Stainless Steel
MAN-	Additional RHE manual printout

Hazardous Area Certifications

Code	Zone / Division	Approval	Labeling
AS	safe area	ATEX IECEX	 II (1)G [Ex ia Ga] IIC [Ex ia Ga] IIC
CS	safe area	USA Kanada	[Ex ia] [Ex ia Ga] IIC



About Rheonik

Rheonik has but one single purpose: to design and manufacture the very best Coriolis meters available.

Our research and engineering resources are dedicated to finding new and better ways to provide cost effective accurate mass flow solutions that provide value to our customers. Our manufacturing group care for each and every meter we produce from raw materials all the way to shipping, and our service and support group are available to help you specify, integrate, start-up and maintain every Rheonik meter you have in service. Whether you own just one meter or have hundreds, you will never be just another customer to us. You are our valued business partner.

Need a specific configuration for your plant? Don't compromise with a "standard" product from elsewhere that will add extra cost to your installation. If we can't configure it from our extensive and versatile product range, our exclusive **AnyPipeFit Commitment** can have your flow sensor customized with any size/type of process connection and face to face dimension you need.

No matter what control system you use as the backbone in your enterprise, with our **AnyInterface Commitment**, you can be sure that connection and communication will not be a problem. Alongside a wide variety of discrete analog and digital signal connections, we can also provide just about any network/bus interface available (for example: HART, ProfibusDP, ProfiNet, EtherCAT, PowerLink, EtherNet/IP, CAN,) with our RHE 40 Series family of transmitters. Rheonik RHE 40 Series transmitters can connect to your system – no headache and no conversion needed.

Rheonik Messtechnik GmbH
Rudolf-Diesel-Straße 5
D-85235 Odelzhausen
Germany

Tel + 49 (0)8134 9341-0
info@rheonik.com

